



DATE : 5. April.2011

SAMSUNG TFT-LCD

MODEL : LTI220MT02

The Information Described in this Specification is Preliminary and can be changed without prior notice

APPROVED BY Kwang-Soo Lee	DATE 5.April.2011	PREPARED BY Dong-Hyun Kim	DATE 5.April.2011
-------------------------------------	----------------------	-------------------------------------	----------------------

Application Engineering Part, LCD Division

Samsung Electronics Co . , LTD.

Contents

Revision History	(3)
General Description	(4)
General Information	(4)
1. Absolute Maximum Ratings	(5)
2. Application information for DID (Digital Information Display)	(6)
3. Optical Characteristics	(7)
4. Electrical Characteristics	(10)
4.1 TFT LCD Module	
5. Input Terminal Pin Assignment	(13)
5.1 Input Signal & Power : TMDS & 5V DC	
5.2 Input Signal & Power : LVDS (Option)	
5.3 LVDS Interface	
5.4 Input Signals, Basic Display Colors and Gray Scale of Each Color	
6. Interface Timing	(17)
6.1 Timing Parameters (DE only mode)	
6.2 Timing Diagrams of interface Signal (DE only mode)	
6.3 LVDS Skew Margin	
6.4 Power ON/OFF Sequence	
7. Outline Dimension	(21)
8. Packing	(23)
9. Marking & Others	(24)
10. General Precaution	(25)
10.1 Handling	
10.2 Storage	
10.3 Operation	
10.4 Operation Condition Guide	
10.5 Others	

*** Revision History**

Date	Rev. No	Page	Summary
April, 5, 2011	000	all	First issued

General Description

Description

LTI220MT02 is a active matrix liquid crystal display (LCD) that uses amorphous silicon TFT(Thin Film Transistor) as switching components. This model is composed of a TFT LCD panel, a driver circuit. The resolution of a 22.0" is 1680 x 1050 and this model can display up to 16.7M colors with wide viewing angle of 80° or higher in all directions. This panel is intended to support applications to provide a excellent performance for Flat Panel Display such as Transparent Display Monitor, Show window, Kiosk etc.

Features

- RoHS compliance (Pb-free)
- High Transmittance
- TN(Twisted Nematic) mode
- Wide viewing angle ($\pm 160^\circ$)
- High speed response
- WXGA (1680 x 1050 pixels) resolution (16:9)
- Low power consumption
- DE(Data Enable) mode
- Interface – TMDS(Main), LVDS(Option)
- Connector - HDMI

Recommend

- Do not use liquid cleaner at LCD surface
- Use cover glass at LCD

General Information

Items	Specification	Unit	Note
Module Size	493.7(H) x 371.0(V)	mm	$\pm 0.5\text{mm}$
	7.0(T1), 22.0(T2)		
Weight	1,300(Max.)	g	
Pixel Pitch	0.282(H) x 0.282(V)	mm	
Active Display Area	473.76(H) x 296.1(V)	mm	
Surface Treatment	Clear LR, Haze 2%		
Display Colors	8 bit – 16.7M	Color	
Number of Pixels	1680 x 1050	pixel	
Pixel Arrangement	RGB vertical stripe		
Display Mode	Normally White		

1. Absolute Maximum Ratings

If the condition exceeds maximum ratings, it can cause malfunction or unrecoverable damage to the device.

Item		Symbol	Min.	Max.	Unit	Note
Power Supply Voltage		V_{DD}	GND-0.5	5.5	V	(1)
Storage temperature		T_{STG}	5	40	°C	(2)
Glass surface temperature (Operation)	Center	T_{CENTER}	0	40	°C	(2),(5)
	T. Uniformity	ΔT	-	10	°C	
Shock (non - operating)		S_{nop}	-	50	G	(3)
Vibration (non - operating)		V_{nop}	-	1.5	G	(4)

Note (1) $T_a = 25 \pm 2 \text{ }^\circ\text{C}$

(2) 20ms, sine wave, one time for $\pm X, \pm Y, \pm Z$ axis

(3) 10-300 Hz, Sweep rate 11min, 30min for X,Y,Z axis

Fig. Temperature and Relative humidity range

(5) Definition of test point

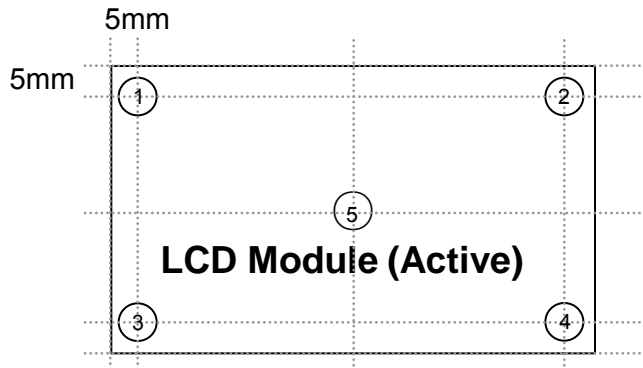

ΔT should be less than $10\text{ }^{\circ}\text{C}$ ($\Delta T = |T_{\text{CENTER}} - T_{\text{CORNER}}|$)

T_{CENTER} : Temperature of the center of the glass surface (Test point 5)

T_{CORNER} : Temperature of each edge of the glass surface (Test point 1~4)

2. Application information for DID (Digital Information Display)

A long-term display like DID application may cause uneven display including image retention. To optimize module's lifetime and function, several operating usages are required.

1. Normal operating condition

- Temperature: $20 \pm 15\text{ }^{\circ}\text{C}$
- Humidity: $55 \pm 20\%$
- Display pattern: moving picture or regular switchover display

Note) Long-term static information image may cause uneven display.

2. Operating usages under abnormal operating condition. Note (1)

- a. Ambient condition
 - Well-ventilated place is recommended to set up DID system.
- b. Power off and screen saver
 - Periodical power-off or screen saver is needed after long-term static display. Note (2)

3. Operating usages to protect uneven display due to long-term static information display

- a. Suitable operating time for E-DID : under 20 hours a day.
- b. Periodical display contents change from static image to moving picture.
 - Liquid crystal refresh time is required.
- c. Periodical background color and character (image) color change
 - Use different colors for background and character (image), respectively.
 - Change colors periodically.
- d. Avoid combination of background and character with large different luminance.

Note (1) Abnormal condition means every operating condition except normal operating condition.

Note (2) Moving picture or black pattern is strongly recommended for screen saver.

4. Lifetime in this spec is guaranteed only when DID is used under right operating usages.

3. Optical Characteristics

The optical characteristics should be measured in a dark room or equivalent.

Measuring equipment : TOPCON RD-80S,SPECTRORADIOMETER SR-3, Eldim EZ-Contrast)

($T_a = 25 \pm 2^\circ\text{C}$, $V_{DD} = 5\text{V}$, $f_v = 60\text{Hz}$, $f_{DCLK} = 59.5\text{MHz}$, $I_L = 8\text{mA}$)

Item	Symbol	Condition	Min.	Typ.	Max.	Unit	Note
Contrast Ratio (Center of screen)	C/R	Normal $\theta_L, R=0$ $\theta_U, D=0$	100	500	-		(3) SR-3
Response Time	On/Off		T_{R+}	-	45	55	msec
		T_F	-	5	8		
Luminance of White (Center of screen)	Y_L	Viewing Angle	150	200	-	cd/m ²	(6) SR-3
Transmittance	%		12	15			(4-1) SR-3
Color Gamut	-		-	5	-	%	(7) SR-3
Cross Modulation	C_T		-	-	5	%	(7) SR-3
Viewing Angle	Hor.	θ_L	70	80	-	Degree	(8) SR-3
		θ_R	70	80	-		
	Ver.	θ_U	50	60	-		
		θ_D	70	80	-		
Gamma Value			1.1	1.5	1.9		

Note (1) Test Equipment Setup

The measurement should be executed in a stable, windless and dark room between 40min and 60min after lighting the backlight at the given temperature for stabilization of the backlight. This should be measured in the center of screen.

Single lamp current : 8mA

Environment condition : $T_a = 25 \pm 2^\circ\text{C}$

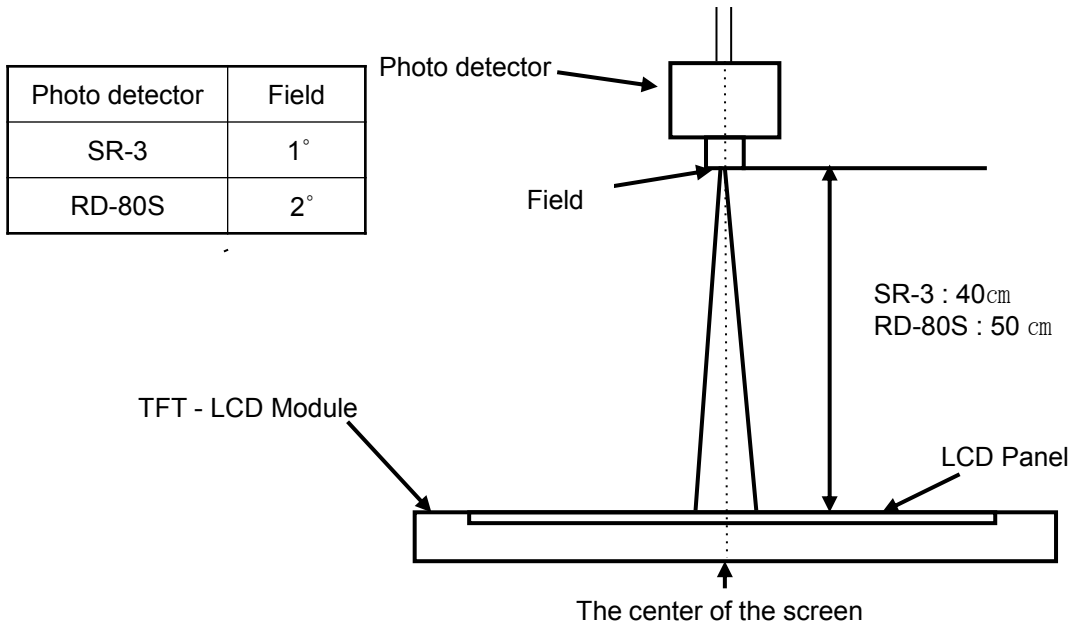

Note (2) Definition of test point

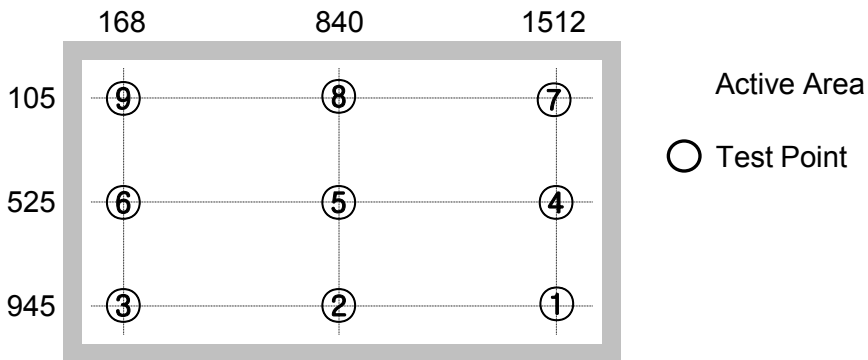

Note (3) Definition of Contrast Ratio (C/R)

: Ratio of gray max (Gmax) & gray min (Gmin) at the center point ⑤ of the panel

$$C/R = \frac{G_{\max}}{G_{\min}}$$

Gmax : Luminance with all pixels white

Gmin : Luminance with all pixels black

Note (4) Definition of Transmittance

Measure Pattern : Fully white

$$\frac{\text{The intensity of radiation(Output)}}{\text{The intensity of radiation(Input)}} * 100$$

Note (5) Definition of Response time : Average response time of all Gray to Gray except Tr, Tf

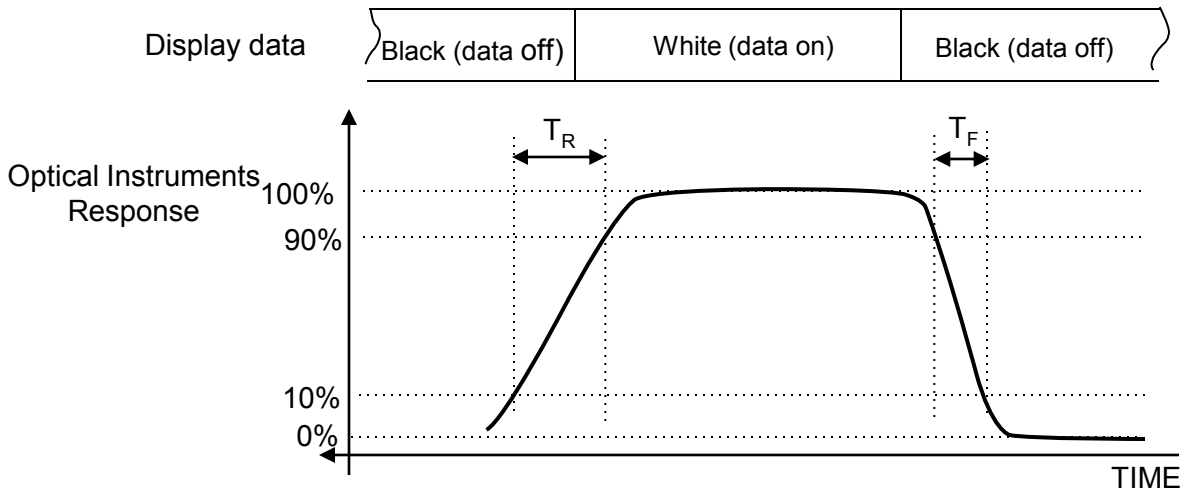

Note (6) Definition of Luminance of White : Luminance of white at center point ⑤
 Environment of measurement : 1500lux(= ref : BLU 1000nit)

Note (7) Definition of Color Chromaticity (CIE 1931)
 Color coordinate of Red, Green, Blue & White at center point ⑤

Note (8) Definition of Viewing Angle
 : Viewing angle range (C/R ≥ 10)

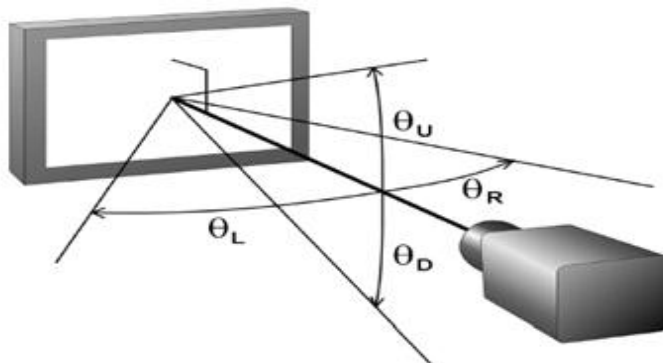

4. Electrical Characteristics

4.1 TFT LCD Module

The connector for display data & timing signal should be connected.

Ta = 25°C ± 2 °C

Item		Symbol	Min.	Typ.	Max.	Unit	Note
Voltage of Power Supply		V _{DD}	4.5	5.0	5.5	V	(1)
Current of Power Supply	(a) Black	I _{DD}	-	1500	1900	mA	(2),(3)
	(b) White		-	1200	1500	mA	
Interface Type		LVDS	DS90C383/385/387 DS90C386 Pair				
		TMDS	Si1160				
Vsync Frequency		f _V	40	60	77	Hz	
Hsync Frequency		f _H	43.8	64.8	83.2	kHz	
Main Frequency		f _{DCLK}	42.4	59.6	75.5	MHz	
Rush Current		I _{RUSH}	-	-	4	A	(4)

Note (1) The ripple voltage should be controlled under 10% of V_{DD}.

(2) f_V = 60Hz, f_{DCLK} = 59.6 MHz, V_{DD} = 5.0V, DC Current.

(3) Power dissipation check pattern (LCD Module only)

a) Black Pattern b) White Pattern



(4) Measurement Conditions

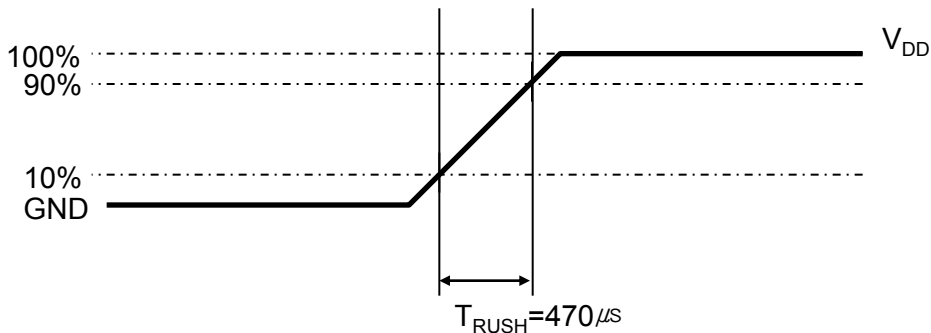

Rush Current I_{RUSH} can be measured when T_{RUSH} is 470 μs.

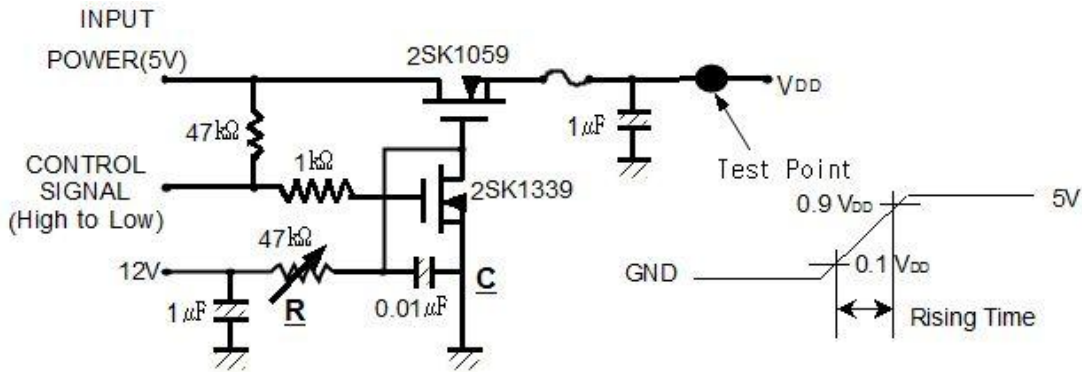

Control Signal : High(+5V) -->Low(Ground)
 All Signal lines to panel except for power 5V : Ground
 The rising time of supplied voltage is controlled to 470us by R and C value.

5. Input Terminal Pin Assignment

5.1 Input Signal & Power : TMDS & 5V DC

PIN No.	Description	PIN No.	Description
1	TMDS data 2+	11	TMDS clock shield
2	TMDS data 2 shield	12	TMDS clock -
3	TMDS data 2-	13	CEC
4	TMDS data 1+	14	N.C
5	TMDS data 1 shield	15	SCL
6	TMDS data 1-	16	SDA
7	TMDS data 0+	17	DDC/CEC Ground
8	TMDS data 0 shield	18	+5V Power
9	TMDS data 0-	19	Hot Plug Detect
10	TMDS clock +		

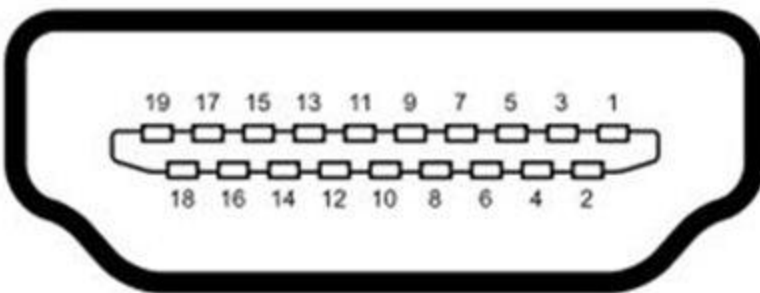

Voltage of power	5V
Current of power	3A
Diameter	4π(External) 1.7π (Internal)

Fig. HDMI Connector Pin Map and Adapter spec

5.2 Input Signal & Power : LVDS (Option)

(Connector UJU IS100-L300-C23 or Compatible connect)

PIN No.	Function		Description	PIN No.	Function		Description
1	Pixel 0(N)	ODD LVDS SIGNAL	RX00-	16	Pixel 1(N)	EVEN	RXE1+
2	Pixel 0(P)		RX00+	17	GND		GND
3	Pixel 1(N)		RX01-	18	Pixel 2(N)	EVEN LVDS SIGNAL	RXE2-
4	Pixel 1(P)		RX01+	19	Pixel 2(P)		RXE2+
5	Pixel 2(N)		RX02-	20	Clock (N)		RXEC-
6	Pixel 2(P)		RX02+	21	Clock (P)		RXEC+
7	GND		GND	22	Pixel 3(N)		RXE3-
8	Clock (N)	ODD LVDS SIGNAL	RXOC-	23	Pixel 3(P)		RXE3+
9	Clock (P)		RXOC+	24	GND		GND
10	Pixel 3(N)		RX03-	25	CE		CE
11	Pixel 3(P)	RX03+	26	CTL		CTL	
12	Pixel 0(N)	EVEN	RXE0-	27	N.C		NC
13	Pixel 0(P)		RXE0+	28	+5V		V _{DD}
14	GND		GND	29	+5V		V _{DD}
15	Pixel 1(P)	EVEN	RXE1-	30	+5V		V _{DD}

5.3 LVDS Interface

5.3.1 Odd pixel data (1st pixel data)1st LVDS Transmitter (*DS90C385*) Signal Interface

Device Input Pin		Device Input Signal		Output Signal	To LTI220MT01 Interface (CN101)	
No	Symbol	Symbol	Function		Terminal	Symbol
51	TXIN0	RO0	Red Odd Pixel Data (LSB)	TXOUT0- TXOUT0+	No. 2 No. 3	RXO0- RXO0+
52	TXIN1	RO1	Red Odd Pixel Data			
54	TXIN2	RO2	Red Odd Pixel Data			
55	TXIN3	RO3	Red Odd Pixel Data			
56	TXIN4	RO4	Red Odd Pixel Data			
2	TXIN5	RO7	Red Odd Pixel Data (MSB)	TXOUT3- TXOUT3+	No. 11 No. 12	RXO3- RXO3+
3	TXIN6	RO5	Red Odd Pixel Data	TXOUT0- TXOUT0+	No. 2 No. 3	RXO0- RXO0+
4	TXIN7	GO0	Green Odd Pixel Data (LSB)			
6	TXIN8	GO1	Green Odd Pixel Data	TXOUT1- TXOUT1+	No. 4 No. 5	RXO1- RXO1+
7	TXIN9	GO2	Green Odd Pixel Data			
8	TXIN10	GO6	Green Odd Pixel Data			
10	TXIN11	GO7	Green Odd Pixel Data (MSB)	TXOUT3- TXOUT3+	No. 11 No. 12	RXO3- RXO3+
11	TXIN12	GO3	Green Odd Pixel Data	TXOUT1- TXOUT1+	No. 4 No. 5	RXO1- RXO1+
12	TXIN13	GO4	Green Odd Pixel Data			
14	TXIN14	GO5	Green Odd Pixel Data			
15	TXIN15	BO0	Blue Odd Pixel Data (LSB)	TXOUT3- TXOUT3+	No. 11 No. 12	RXO3- RXO3+
16	TXIN16	BO6	Blue Odd Pixel Data			
18	TXIN17	BO7	Blue Odd Pixel Data (MSB)			
19	TXIN18	BO1	Blue Odd Pixel Data	TXOUT1- TXOUT1+	No. 4 No. 5	RXO1- RXO1+
20	TXIN19	BO2	Blue Odd Pixel Data	TXOUT2- TXOUT2+	No. 6 No. 7	RXO2- RXO2+
22	TXIN20	BO3	Blue Odd Pixel Data			
23	TXIN21	BO4	Blue Odd Pixel Data			
24	TXIN22	BO5	Blue Odd Pixel Data			
50	TXIN27	RO6	Red Odd Pixel Data	TXOUT3- TXOUT3+	No. 11 No. 12	RXO3- RXO3+

5.3.2 Even pixel data (2nd pixel data)

2nd LVDS Transmitter (<i>DS90C385</i>) Signal Interface						
Device Input Pin		Device Input Signal		Output Signal	To LTI220MT01 Interface (CN101)	
No	Symbol	Symbol	Function		Terminal	Symbol
51	TXIN0	RE0	Red Even Pixel Data (LSB)	TXOUT0- TXOUT0+	No. 13 No. 14	RXE0- RXE0+
52	TXIN1	RE1	Red Even Pixel Data			
54	TXIN2	RE2	Red Even Pixel Data			
55	TXIN3	RE3	Red Even Pixel Data			
56	TXIN4	RE4	Red Even Pixel Data			
2	TXIN5	RE7	Red Even Pixel Data (MSB)	TXOUT3- TXOUT3+	No. 23 No. 24	RXE3- RXE3+
3	TXIN6	RE5	Red Even Pixel Data	TXOUT0- TXOUT0+	No. 13 No. 14	RXE0- RXE0+
4	TXIN7	GE0	Green Even Pixel Data (LSB)			
6	TXIN8	GE1	Green Even Pixel Data	TXOUT1- TXOUT1+	No. 16 No. 17	RXE1- RXE1+
7	TXIN9	GE2	Green Even Pixel Data			
8	TXIN10	GE6	Green Even Pixel Data	TXOUT3- TXOUT3+	No. 23 No. 24	RXE3- RXE3+
10	TXIN11	GE7	Green Even Pixel Data (MSB)			
11	TXIN12	GE3	Green Even Pixel Data	TXOUT1- TXOUT1+	No. 16 No. 17	RXE1- RXE1+
12	TXIN13	GE4	Green Even Pixel Data			
14	TXIN14	GE5	Green Even Pixel Data			
15	TXIN15	BE0	Blue Even Pixel Data (LSB)	TXOUT3- TXOUT3+	No. 23 No. 24	RXE3- RXE3+
16	TXIN16	BE6	Blue Even Pixel Data			
18	TXIN17	BE7	Blue Even Pixel Data (MSB)	TXOUT1- TXOUT1+	No. 16 No. 17	RXE1- RXE1+
19	TXIN18	BE1	Blue Even Pixel Data			
20	TXIN19	BE2	Blue Even Pixel Data			
22	TXIN20	BE3	Blue Even Pixel Data	TXOUT2- TXOUT2+	No. 19 No. 20	RXE2- RXE2+
23	TXIN21	BE4	Blue Even Pixel Data			
24	TXIN22	BE5	Blue Even Pixel Data			
50	TXIN27	RE6	Red Even Pixel Data	TXOUT3- TXOUT3+	No. 23 No. 24	RXE3- RXE3+

5.3.3 Odd pixel data (1st pixel data)

Note: 24th BAL pin : low, 23th DUAL pin : high

LVDS Transmitter (**DS90C387**) Signal Interface

Device Input Pin		Device Input Signal		Output Signal	To LTI220MT01 Interface (CN101)	
No	Symbol	Symbol	Function		Terminal	Symbol
10	R10	RO0	Red Odd Pixel Data (LSB)	A0M A0P	No. 2 No. 3	RXO0- RXO0+
9	R11	RO1	Red Odd Pixel Data			
8	R12	RO2	Red Odd Pixel Data			
7	R13	RO3	Red Odd Pixel Data			
6	R14	RO4	Red Odd Pixel Data			
3	R17	RO7	Red Odd Pixel Data (MSB)	A3M A3P	No. 11 No. 12	RXO3- RXO3+
5	R15	RO5	Red Odd Pixel Data	A0M A0P	No. 2 No. 3	RXO0- RXO0+
2	G10	GO0	Green Odd Pixel Data (LSB)			
1	G11	GO1	Green Odd Pixel Data	A1M A1P	No. 4 No. 5	RXO1- RXO1+
100	G12	GO2	Green Odd Pixel Data			
94	G16	GO6	Green Odd Pixel Data			
93	G17	GO7	Green Odd Pixel Data (MSB)	A3M A3P	No. 11 No. 12	RXO3- RXO3+
99	G13	GO3	Green Odd Pixel Data	A1M A1P	No. 4 No. 5	RXO1- RXO1+
96	G14	GO4	Green Odd Pixel Data			
95	G15	GO5	Green Odd Pixel Data			
92	B10	BO0	Blue Odd Pixel Data (LSB)	A3M A3P	No. 11 No. 12	RXO3- RXO3+
86	B16	BO6	Blue Odd Pixel Data			
85	B17	BO7	Blue Odd Pixel Data (MSB)			
91	B11	BO1	Blue Odd Pixel Data			
90	B12	BO2	Blue Odd Pixel Data			
89	B13	BO3	Blue Odd Pixel Data	A2M A2P	No. 6 No. 7	RXO2- RXO2+
88	B14	BO4	Blue Odd Pixel Data			
87	B15	BO5	Blue Odd Pixel Data			
4	R16	RO6	Red Odd Pixel Data	A3M A3P	No. 11 No. 12	RXO3- RXO3+

5.3.4 Even pixel data (2nd pixel data)

Note: 24th BAL pin : low,23th DUAL pin : high

LVDS Transmitter (**DS90C387**) Signal Interface

Device Input Pin		Device Input Signal		Output Signal	To LTI220MT01 Interface (CN101)	
No	Symbol	Symbol	Function		Terminal	Symbol
84	R20	RE0	Red Even Pixel Data (LSB)	A4M A4P	No. 13 No. 14	RXE0- RXE0+
81	R21	RE1	Red Even Pixel Data			
80	R22	RE2	Red Even Pixel Data			
79	R23	RE3	Red Even Pixel Data			
78	R24	RE4	Red Even Pixel Data			
75	R27	RE7	Red Even Pixel Data (MSB)	A7M A7P	No. 23 No. 24	RXE3- RXE3+
77	R25	RE5	Red Even Pixel Data	A4M A4P	No. 13 No. 14	RXE0- RXE0+
74	G20	GE0	Green Even Pixel Data (LSB)			
73	G21	GE1	Green Even Pixel Data	A5M A5P	No. 16 No. 17	RXE1- RXE1+
72	G22	GE2	Green Even Pixel Data			
66	G26	GE6	Green Even Pixel Data	A7M A7P	No. 23 No. 24	RXE3- RXE3+
65	G27	GE7	Green Even Pixel Data (MSB)			
71	G23	GE3	Green Even Pixel Data	A5M A5P	No. 16 No. 17	RXE1- RXE1+
70	G24	GE4	Green Even Pixel Data			
69	G25	GE5	Green Even Pixel Data			
64	B20	BE0	Blue Even Pixel Data (LSB)	A7M A7P	No. 23 No. 24	RXE3- RXE3+
58	B26	BE6	Blue Even Pixel Data			
57	B27	BE7	Blue Even Pixel Data (MSB)			
63	B21	BE1	Blue Even Pixel Data	A5M A5P	No. 16 No. 17	RXE1- RXE1+
62	B22	BE2	Blue Even Pixel Data	A6M A6P	No. 19 No. 20	RXE2- RXE2+
61	B23	BE3	Blue Even Pixel Data			
60	B24	BE4	Blue Even Pixel Data			
59	B25	BE5	Blue Even Pixel Data			
76	R26	RE6	Red Even Pixel Data	A7M A7P	No. 23 No. 24	RXE3- RXE3+

5.3.5 pixel data (TMDS)

TMDS Transmitter (*Sil1160*) Signal Interface

Device Input Pin		Device Input Signal		Output Signal	To LTI220MT01 Interface (CON_TMDS)	
					Terminal	Symbol
No	Symbol	Symbol	Function			
97	DIE16	RO0	Red Odd Pixel Data (LSB)	TX0- TX0+	No. 9 No. 7	TX0- TX0+
96	DIE17	RO1	Red Odd Pixel Data			
95	DIE18	RO2	Red Odd Pixel Data			
94	DIE19	RO3	Red Odd Pixel Data			
93	DIE20	RO4	Red Odd Pixel Data			
92	DIE21	RO5	Red Odd Pixel Data			
91	DIE22	RO6	Red Odd Pixel Data			
90	DIE23	RO7	Red Odd Pixel Data (MSB)			
55	DIO16	RE0	Red Even Pixel Data (LSB)			
54	DIO17	RE1	Red Even Pixel Data			
53	DIO18	RE2	Red Even Pixel Data			
52	DIO19	RE3	Red Even Pixel Data			
51	DIO20	RE4	Red Even Pixel Data			
50	DIO21	RE5	Red Even Pixel Data			
49	DIO22	RE6	Red Even Pixel Data			
48	DIO23	RE7	Red Even Pixel Data (MSB)			
6	DIE8	GO0	Green Odd Pixel Data (LSB)	TX1- TX1+	No. 6 No. 4	TX1- TX1+
5	DIE9	GO1	Green Odd Pixel Data			
4	DIE10	GO2	Green Odd Pixel Data			
3	DIE11	GO3	Green Odd Pixel Data			
2	DIE12	GO4	Green Odd Pixel Data			
1	DIE13	GO5	Green Odd Pixel Data			
100	DIE14	GO6	Green Odd Pixel Data			
99	DIE15	GO7	Green Odd Pixel Data (MSB)			
65	DIO8	GE0	Green Even Pixel Data (LSB)			
64	DIO9	GE1	Green Even Pixel Data			
63	DIO10	GE2	Green Even Pixel Data			
62	DIO11	GE3	Green Even Pixel Data			
61	DIO12	GE4	Green Even Pixel Data			
60	DIO13	GE5	Green Even Pixel Data			
59	DIO14	GE6	Green Even Pixel Data			
58	DIO15	GE7	Green Even Pixel Data (MSB)			

TMD5 Transmitter (*Sil1160*) Signal Interface

Device Input Pin		Device Input Signal		Output Signal	To LTI220MT01 Interface (CON_TMDS)	
No	Symbol	Symbol	Function		Terminal	Symbol
16	DIE0	BO0	Blue Odd Pixel Data (LSB)	TX2- TX2+	No. 3 No. 1	TX2- TX2+
15	DIE1	BO1	Blue Odd Pixel Data			
14	DIE2	BO2	Blue Odd Pixel Data			
13	DIE3	BO3	Blue Odd Pixel Data			
12	DIE4	BO4	Blue Odd Pixel Data			
11	DIE5	BO5	Blue Odd Pixel Data			
10	DIE6	BO6	Blue Odd Pixel Data			
9	DIE7	BO7	Blue Odd Pixel Data (MSB)			
75	DIO0	BE0	Blue Even Pixel Data (LSB)			
74	DIO1	BE1	Blue Even Pixel Data			
73	DIO2	BE2	Blue Even Pixel Data			
72	DIO3	BE3	Blue Even Pixel Data			
71	DIO4	BE4	Blue Even Pixel Data			
70	DIO5	BE5	Blue Even Pixel Data			
69	DIO6	BE6	Blue Even Pixel Data			
68	DIO7	BE7	Blue Even Pixel Data (MSB)			

5.4 Input Signals, Basic Display Colors and Gray Scale of Each Color

COLOR	DISPLAY (8bit)	DATA SIGNAL																					GRAY SCALE LEVEL			
		RED							GREEN							BLUE										
		R0	R1	R2	R3	R4	R5	R6	R7	G0	G1	G2	G3	G4	G5	G6	G7	B0	B1	B2	B3	B4		B5	B6	B7
BASIC COLOR	BLACK	0	0	0	0	0	0	0	0	0	0	0	0	0	0	0	0	0	0	0	0	0	0	0	0	-
	BLUE	0	0	0	0	0	0	0	0	0	0	0	0	0	0	0	0	1	1	1	1	1	1	1	1	-
	GREEN	0	0	0	0	0	0	0	0	1	1	1	1	1	1	1	1	0	0	0	0	0	0	0	0	-
	CYAN	0	0	0	0	0	0	0	0	1	1	1	1	1	1	1	1	1	1	1	1	1	1	1	1	-
	RED	1	1	1	1	1	1	1	1	0	0	0	0	0	0	0	0	0	0	0	0	0	0	0	0	-
	MAGENTA	1	1	1	1	1	1	1	1	0	0	0	0	0	0	0	0	1	1	1	1	1	1	1	1	-
	YELLOW	1	1	1	1	1	1	1	1	1	1	1	1	1	1	1	1	0	0	0	0	0	0	0	0	-
	WHITE	1	1	1	1	1	1	1	1	1	1	1	1	1	1	1	1	1	1	1	1	1	1	1	1	-
GRAY SCALE OF RED	BLACK	0	0	0	0	0	0	0	0	0	0	0	0	0	0	0	0	0	0	0	0	0	0	0	R0	
	DARK ↑	1	0	0	0	0	0	0	0	0	0	0	0	0	0	0	0	0	0	0	0	0	0	0	0	R1
		0	1	0	0	0	0	0	0	0	0	0	0	0	0	0	0	0	0	0	0	0	0	0	0	R2
		:	:	:	:	:	:	:	:	:	:	:	:	:	:	:	:	:	:	:	:	:	:	:	:	R3~ R252
		:	:	:	:	:	:	:	:	:	:	:	:	:	:	:	:	:	:	:	:	:	:	:	:	
	LIGHT ↓	1	0	1	1	1	1	1	1	0	0	0	0	0	0	0	0	0	0	0	0	0	0	0	0	R253
		0	1	1	1	1	1	1	1	0	0	0	0	0	0	0	0	0	0	0	0	0	0	0	0	R254
	RED	1	1	1	1	1	1	1	1	0	0	0	0	0	0	0	0	0	0	0	0	0	0	0	0	R255
GRAY SCALE OF GREEN	BLACK	0	0	0	0	0	0	0	0	0	0	0	0	0	0	0	0	0	0	0	0	0	0	0	G0	
	DARK ↑	0	0	0	0	0	0	0	0	1	0	0	0	0	0	0	0	0	0	0	0	0	0	0	0	G1
		0	0	0	0	0	0	0	0	0	1	0	0	0	0	0	0	0	0	0	0	0	0	0	0	G2
		:	:	:	:	:	:	:	:	:	:	:	:	:	:	:	:	:	:	:	:	:	:	:	:	G3~ G252
		:	:	:	:	:	:	:	:	:	:	:	:	:	:	:	:	:	:	:	:	:	:	:	:	
	LIGHT ↓	0	0	0	0	0	0	0	0	1	0	1	1	1	1	1	1	0	0	0	0	0	0	0	0	G253
		0	0	0	0	0	0	0	0	0	1	1	1	1	1	1	1	0	0	0	0	0	0	0	0	G254
	GREEN	0	0	0	0	0	0	0	0	1	1	1	1	1	1	1	1	0	0	0	0	0	0	0	0	G255
GRAY SCALE OF BLUE	BLACK	0	0	0	0	0	0	0	0	0	0	0	0	0	0	0	0	0	0	0	0	0	0	0	B0	
	DARK ↑	0	0	0	0	0	0	0	0	0	0	0	0	0	0	0	0	1	0	0	0	0	0	0	0	B1
		0	0	0	0	0	0	0	0	0	0	0	0	0	0	0	0	0	1	0	0	0	0	0	0	B2
		:	:	:	:	:	:	:	:	:	:	:	:	:	:	:	:	:	:	:	:	:	:	:	:	B3~ B252
		:	:	:	:	:	:	:	:	:	:	:	:	:	:	:	:	:	:	:	:	:	:	:	:	
	LIGHT ↓	0	0	0	0	0	0	0	0	0	0	0	0	0	0	0	0	1	0	1	1	1	1	1	1	B253
		0	0	0	0	0	0	0	0	0	0	0	0	0	0	0	0	0	1	1	1	1	1	1	1	B254
	BLUE	0	0	0	0	0	0	0	0	0	0	0	0	0	0	0	0	1	1	1	1	1	1	1	1	B255

Note)

(1) Definition of Gray : Rn : Red Gray, Gn : Green Gray, Bn : Blue Gray (n = Gray level)
 Input Signal : 0 = Low level voltage, 1 = High level voltage

6. Interface Timing

6.1 Timing Parameters (DE only mode)

SIGNAL	ITEM	SYMBOL	MIN.	TYP.	MAX.	UNIT	NOTE
Clock	Frequency	1/TC	42.4	59.6	75.5	MHz	(1),(2), (3),(8)
	Hgh Time	TCH	4	-	-	nsec	
	Low Time	TCL	4	-	-	nsec	
Data	Setup Time	TDS	4	-	-	nsec	
	Hold Time	TDH	4	-	-	nsec	
Data Enable	Setup Time	TES	4	-	-	nsec	
Hsync Frequency	Cycle	fH	43.8	64.8	83.2	kHz	(4),(5),(6), (7),(8)
Frame Frequency	Cycle	fV	40	60	77	Hz	
		TV	1059	1080	1100	lines	
Vertical Active Display Term	Display Period	TVD	1050	1050	1050	lines	
	Verticle Blank Period	TVB	9	30	50	lines	
One Line Scanning Time	Cycle	TH	913	920	1004	clocks	
Horizontal Active Display Term	Display Period	THD	840	840	840	clocks	

Note) This product is DE mode.

(1) Test Point : TTL control signal at LVDS Tx input terminal in system

(2) Please refer to the Standard of

DS90C383/DS90C384,DS90C385/DS90C386/DS90C387

(3) Internal Vcc = 3.3V

(4) Optimised Operating Clock Frequency = 59.6 MHz

(5) VESA WSXGA+STANDARD TIMING (Reduced Blinking)

(6) Flicker arise under 60Hz(Tv)

(7) One Line Scanning Timing Max = 75KHz(13.3us)

(8) Clock Freq = Frame Freq x TV(Typ.) x TH(Typ.)

(9) Range of TV & TH(Min,Max) is variable range of Clock Freq(Typ.=119MHz)

6.2 Timing diagrams of interface signal (DE only mode)

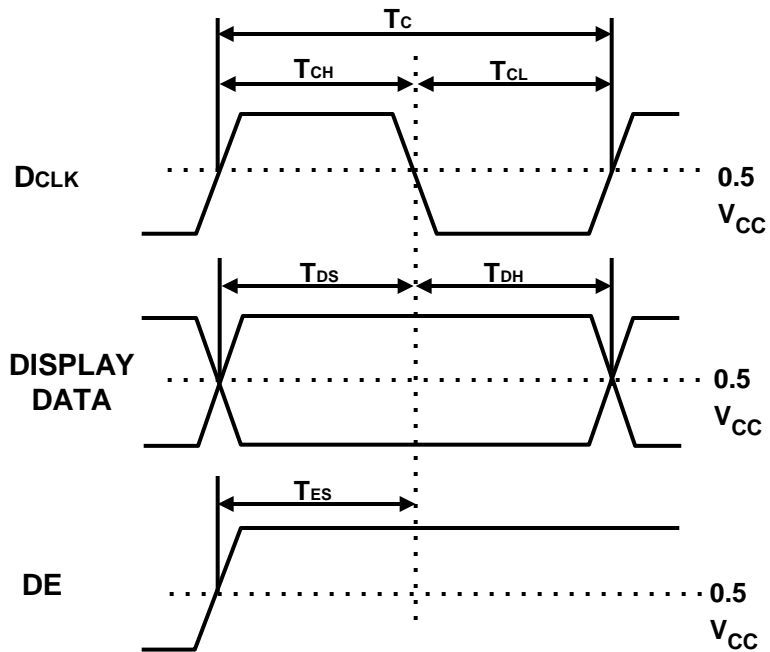
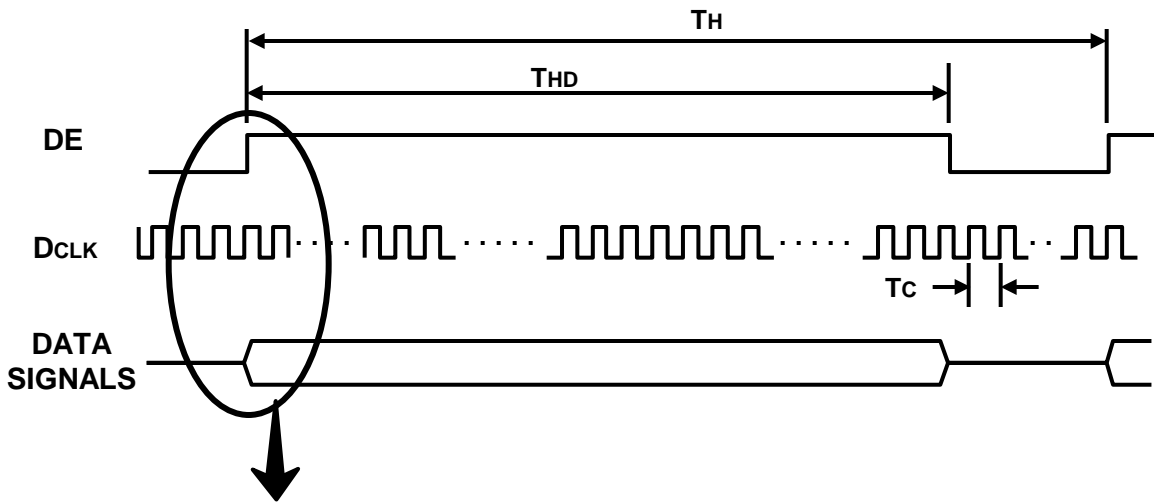
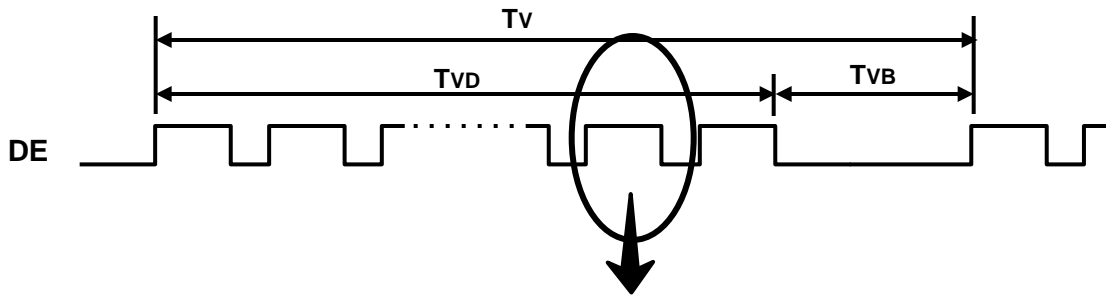

6.3 LVDS Skew Margin

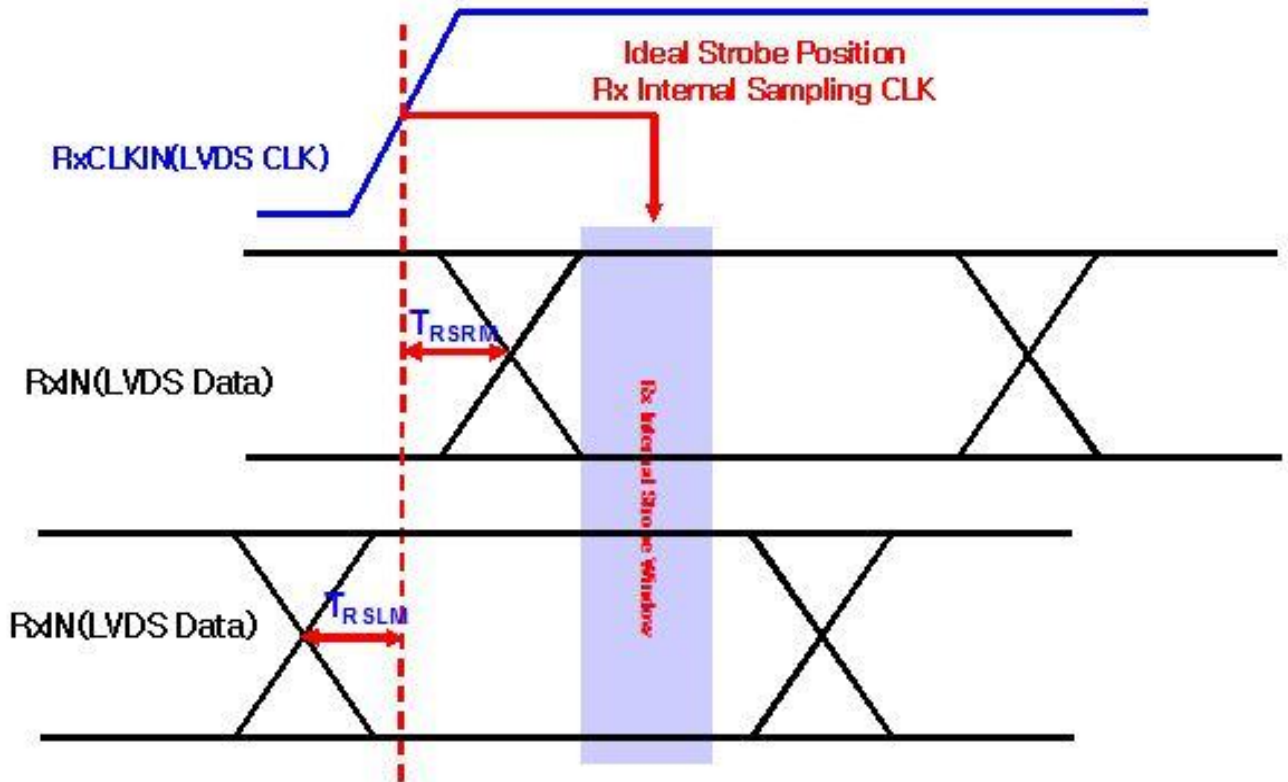

	Min	Max	Condition
T_{RSRM}	-	300 ps	85MHz
T_{RSLM}	- 300 ps	-	

T_{RSRM} : Time of Receiver Skew(Strobe) Right Margin

T_{RSLM} : Time of Receiver Skew(Strobe) Left Margin

6.4 Power ON/OFF Sequence

To prevent a latch-up or DC operation of the LCD Module, the power on/off sequence should be as the diagram below.

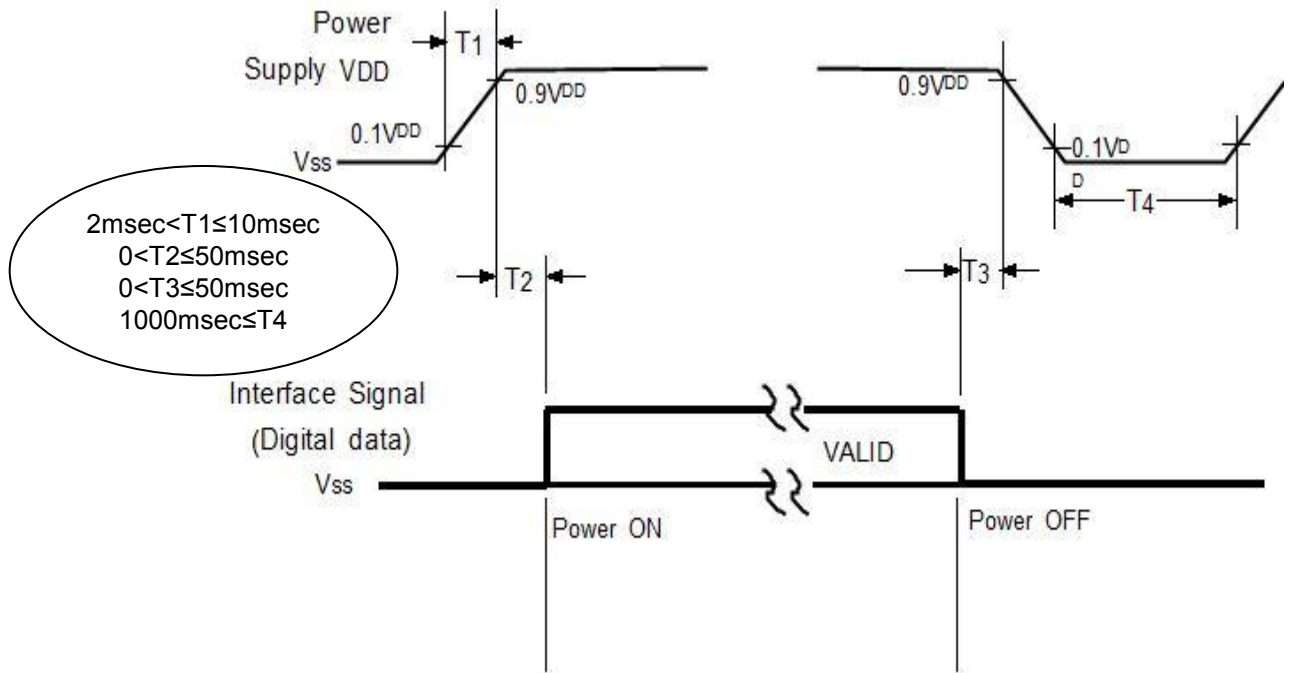

- T1 : V_{DD} rising time from 10% to 90%
- T2 : The time from V_{DD} to valid data at power ON.
- T3 : The time from valid data off to V_{DD} off at power Off.
- T4 : V_{DD} off time for Windows restart

- The supply voltage of the external system for the Module input should be the same as the definition of V_{DD} .
- Apply the lamp voltage within the LCD operation range. When the back light turns on before the LCD operation or the LCD turns off before the back light turns off, the display may momentarily show abnormal screen.
- In case of $V_{DD} = \text{off level}$, please keep the level of input signals low or keep a high impedance.
- T4 should be measured after the Module has been fully discharged between power off and on period.
- Interface signal should not be kept at high impedance when the power is on.

7. Outline Dimension (Front View)

Samsung Confidential

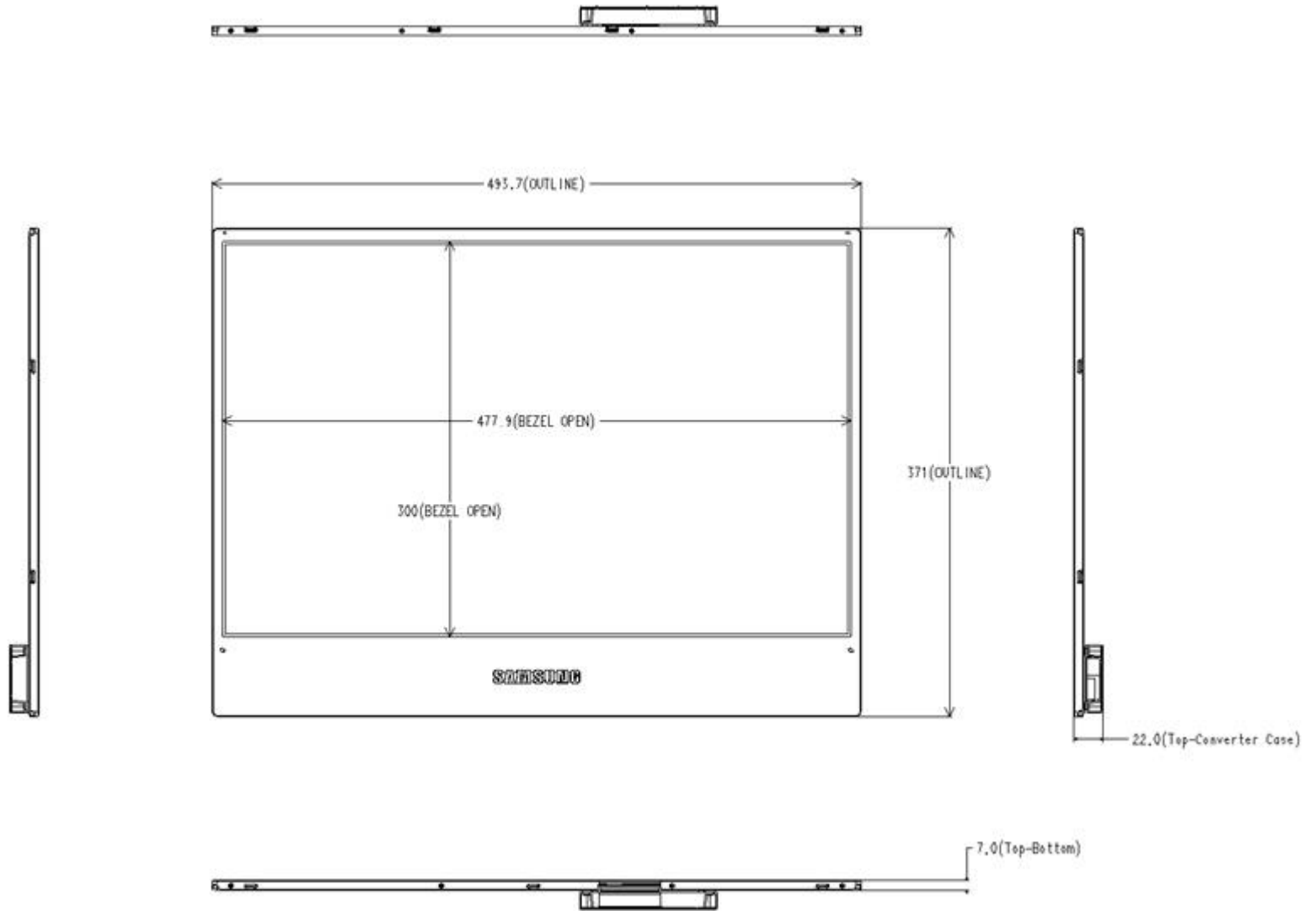

Model

LT1220MT02

Doc. No

05-000-G-110405

Page

24/31

7. Outline Dimension (Rear View)

Samsung Confidential

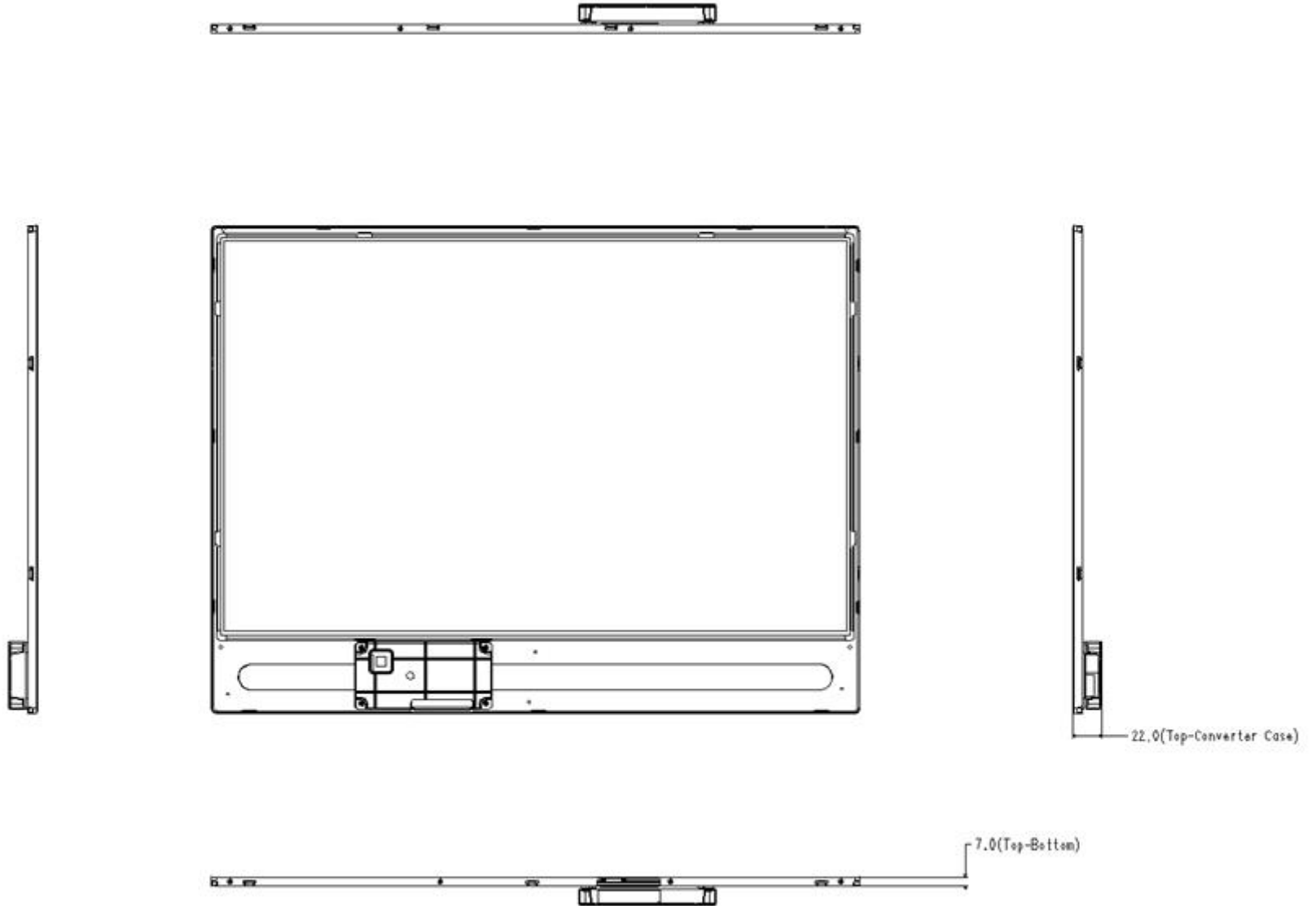

Model

LT1220MT02

Doc. No

05-000-G-110405

Page

25/31

8. PACKING

8.1 CARTON (Internal Package)

(1) Packing Form

Corrugated fiberboard box and corrugated cardboard as shock absorber

(2) Packing Method

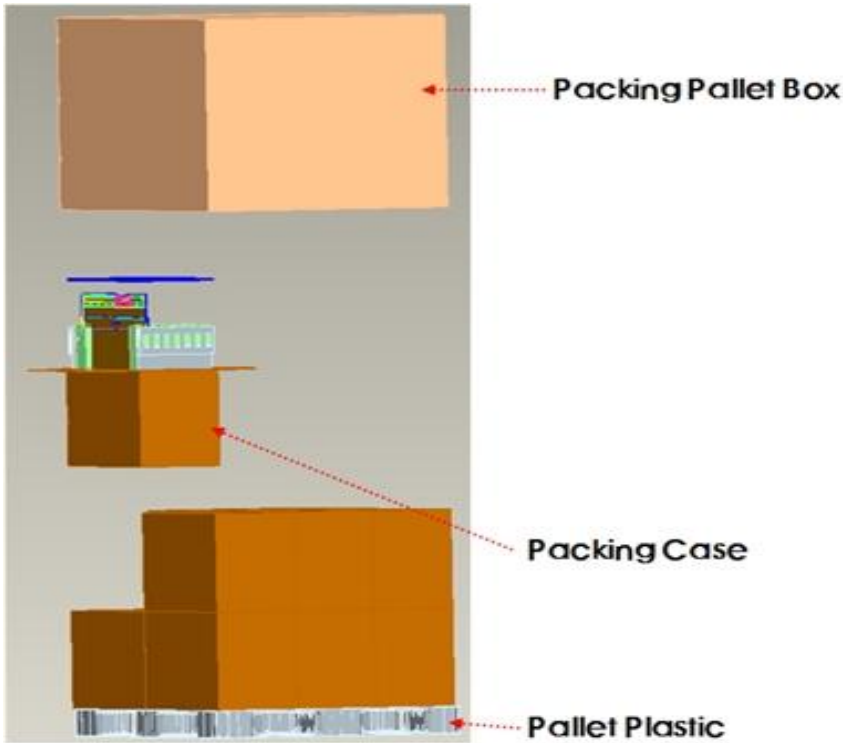

8.2 Packing Specification

Item	Specification	Remark
LCD Packing	144ea / (Packing-Pallet Box)	1. 1.3 Kg / LCD (144ea) 2. 4.2Kg / Packing-pallet box (1ea) 3. 3.5Kg / Packing Case (12ea) 4. 5.3Kg / Pallet Plastic (1ea) 5. Box Material : Paper 6. Packing Pallet Box Material : Paper
Total Pallet Weight	238.7kg	Pallet(5.3kg)+module(1.3* 144= 187.2kg) +Packing case (3.5*12= 42Kg)+Pallet box(4.2Kg)

8.3 Packing Storage condition

ITEM	Unit	Min.	Max.
Storage Temperature	(°C)	5	40
Storage Humidity	(%rH)	35	75
Storage life	12 months		
Storage Condition	<ul style="list-style-type: none"> - . Prohibit direct sunlight - . Ventilation in storehouse and Control changing temperature is within limits of environment - . Put it on pallet, don't put it on floor. and store them with removing from wall. - . Don't wet Out-BOX and avoid rain. - . Without condensation. - . Etc. Avoid harmful Condition. 		

8.4 Packing long-term Storage guide

Long –term Storage Process	More than 3months Storage or Low temp. Delivery/under 5°C Storage, → On the 20°C 50%rH Condition , More than 24hr release.
----------------------------	---

9. MARKING & OTHERS

A nameplate bearing followed by is affixed to a shipped product at the specified location on each product.

- (1) Part number : LTI220MT02
- (2) Revision: Three letters
- (3) Lot number : X X X X XXX XX X

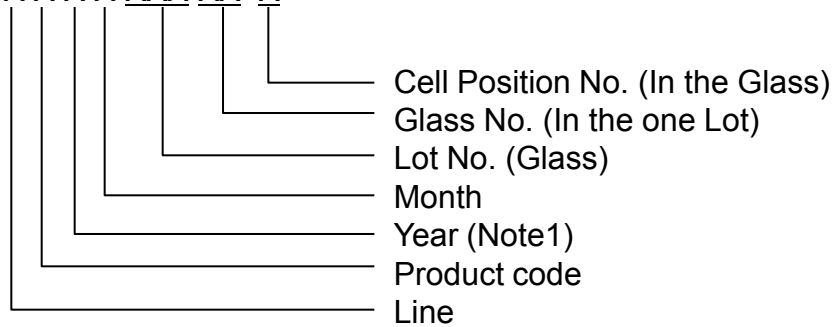

(4) Nameplate Indication

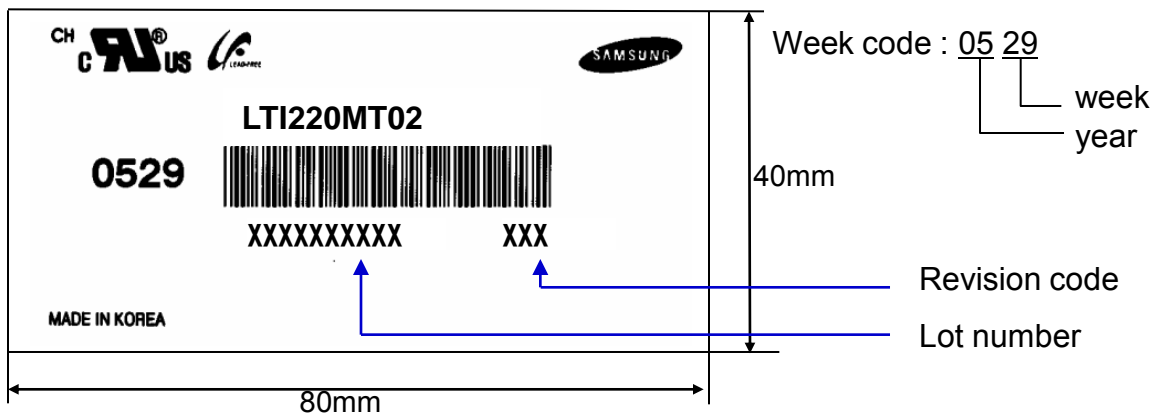

(5) Packing box attach

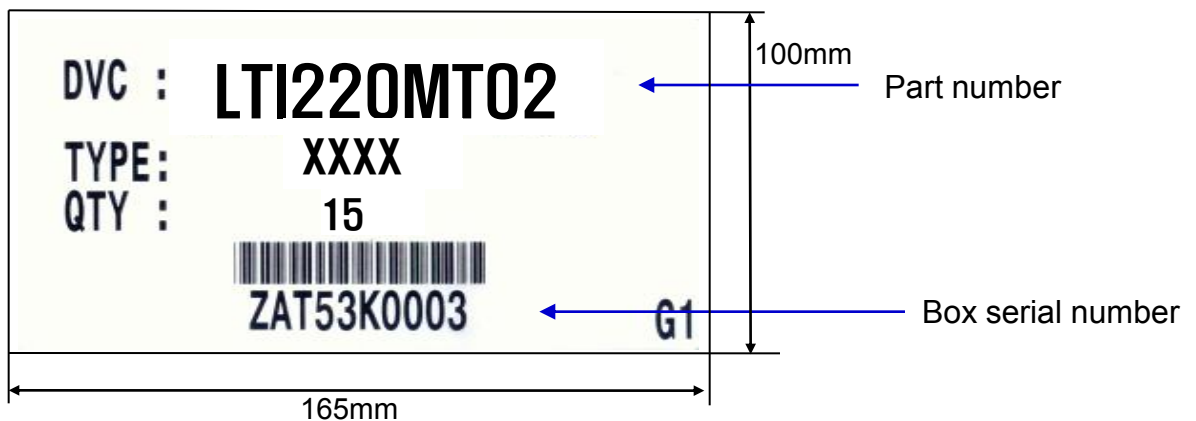

(6) Others

- 1. After service part

Lamps cannot be replaced because of the narrow bezel structure.

10. General Precautions

10.1 Handling

- (a) When the module is assembled, It should be attached to the system firmly using every mounting holes. Be careful not to twist and bend the modules.
- (b) Refrain from strong mechanical shock and / or any force to the module. In addition to damage, this may cause improper operation or damage to the module and back-light.
- (c) Note that polarizers are very fragile and could be easily damaged.
Do not press or scratch the surface harder than a HB pencil lead.
- (d) Wipe off water droplets or oil immediately. If you leave the droplets for a long time, Staining and discoloration may occur.
- (e) If the surface of the polarizer is dirty, clean it using some absorbent cotton or soft cloth.
- (f) The desirable cleaners are water, IPA(Isopropyl Alcohol) or Hexane.
Do not use Ketone type materials(ex. Acetone), Ethyl alcohol, Toluene, Ethyl acid or Methyl chloride.
It might permanent damage to the polarizer due to chemical reaction.
- (g) If the liquid crystal material leaks from the panel, it should be kept away from the eyes or mouth
In case of contact with hands, legs or clothes, it must be washed away thoroughly with soap.
- (h) Protect the module from static , it may cause damage to the CMOS Gate Array IC.
- (i) Use finger-stalls with soft gloves in order to keep display clean during the incoming inspection and assembly process.
- (j) Do not disassemble the module.
- (k) Do not adjust the variable resistor which is located on the module.
- (l) Protection film for polarizer on the module shall be slowly peeled off just before use so that the electrostatic charge can be minimized.

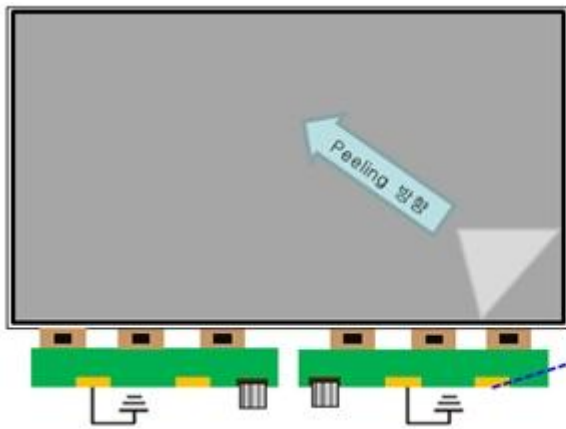

- a. Peel off slowly and constant speed
- b. Be sure to ground S-PBA while peeling of the protection film
- c. The protection film must not touch drivers and S-PBAs

GND SR-Open Pattern
- Be sure to contact with ground while peeling of the protection film

10.2 Storage

- (a) Do not leave the Module in high temperature, and high humidity for a long time. It is highly recommended to store the Module with temperature from 0 to 35°C and relative humidity of less than 70%.
- (b) Do not store the TFT-LCD Module in direct sunlight.
- (c) The Module should be stored in a dark place. It is prohibited to apply sunlight or fluorescent light in storing.

10.3 Operation

- (a) Do not connect or disconnect the Module in the "Power On" condition.
- (b) Power supply should always be turned on/off by the "Power on/off sequence"
- (c) Module has high frequency circuits. Sufficient suppression to the electromagnetic interference should be done by system manufacturers.
Grounding and shielding methods may be important to minimize the interference.

10.4 Others

- (a) Ultra-violet ray filter is necessary for outdoor operation.
- (b) Avoid condensation of water. It may result in improper operation or disconnection of electrode.
- (c) Do not exceed the absolute maximum rating value. (the supply voltage variation, Input voltage variation, variation in part contents and environmental temperature, and so on) Otherwise the module may be damaged.
- (d) If the module displays the same pattern continuously for a long period of time, it can be the situation when the image "Sticks" to the screen.
- (e) This module has its circuitry PCB's on the rear side and should be handled carefully in order not to be stressed.