



# TFT-LCD MONITOR

## Product Information

*Temporary*

**MODEL NO. : T156W1D1**

**Date : 2009.01.13 Rev. 0.1**

**Prepared by :** Nicholas Shih

*Nicholas Shih, Engineer, Product Development Div.*

**Approved by :** Jackey Chien

*Jackey Chen, Director,, Product Development Div.*

This TFT LCD Monitor is distributed by:



Display Solution AG  
Talhofstraße 32a  
D-82205 Gilching  
GERMANY  
Fon +49 (0)8105 / 73 403 - 0  
Fax +49 (0)8105 / 73 403 - 79  
E-Mail: info@display-solution.com  
Internet: www.display-solution.com

This product specification is subject to change without any notice.



## Records of Revision

Date	Rev. No.	Summary	Page
2009.1.13	0.1	First Issue	1



<b>Contents</b>	<b>Page</b>
<b>1.0 Handling Precautions</b>	<b>4</b>
<b>2.0 General Description</b>	<b>5</b>
2.1 General Application	5
2.2 Main Features	5
2.3 General Information	5
2.3.1 Display Characteristics	5
2.3.2 Mechanical Dimensions	6
<b>3.0 Absolute Maximum Ratings</b>	<b>7</b>
3.1 Absolute Ratings of Environment Requirement	7
3.2 Electrical Absolute Ratings	7
3.2.1 TFT-LCD Module	7
3.2.2 Backlight Module(LED)	7
<b>4.0 Optical Characteristics</b>	<b>8</b>
<b>5.0 Electrical Characteristics</b>	<b>10</b>
5.1 AC Timing Characteristics	10
5.2 DC Characteristics	10
5.2.1 TFT-LCD Module	10
5.2.2 Backlight Unit & LED Driver	11
5.3 Input Terminal Pin Assignment	11
5.3.1 Signal Input Interface	11
5.3.2 LED Driver Unit	12
5.3.3 Scanning Direction	12
5.3.4 Color Data Reference	13
5.4 Input Timing Chart	15
<b>6.0 Pixel Format Image</b>	<b>16</b>
<b>7.0 Display Outline Dimensions</b>	<b>16</b>
<b>8.0 Labeling, Packaging &amp; Others</b>	<b>19</b>
<b>9.0 General Notices</b>	<b>21</b>
9.1 Reliability Test Item	21
9.2 Storage, Operation & Others	22



## 1.0 Handling Precaution

- 1.) Handle with care. Pay attention not to press or scratch the surface of the monitor, especially the polarizer. Do not twist or bend the monitor. It may cause un-recoverable damage.
- 2.) Do not drop or bump the monitor since this monitor contains fragile glass components. Breakage of this monitor might cause leakage of the liquid crystal sealed inside the glasses. Do not touch the liquid crystal liquid in case of leakage. **Flush with massive water immediately in case of contact with your skin by liquid crystal fluid and call for doctor for immediate medical treatment.**
- 3.) Be sure to turn off power supply while plug or un-plug the power input connector.
- 4.) Clean up the polarizer only with soft solvent if necessary. The desirable cleaners are water, IPA(Isopropyl Alcohol) or Hexane. Do not use Ketone type materials (ex. Acetone), Ethyl alcohol, toluene, Ethyl acid or Methyl chloride. It will permanently damage the polarizer due to chemical reaction. 5.) Wipe off fluid drop immediately to prevent from possible discoloration or spots on the polarizer.
- 6.) Do not twist nor bend the monitor structure, even momentarily. Bending or twisting torque may likely damage the internal components of the monitor.
- 7.) Protect the monitor from static environment to prevent from damage to the CMOS gate array IC.



## 2.0 General Description

T156W1D1 is a 15.6 inch (TRUE 16:9 wide aspect ratio) color active matrix TFT LCD monitor with excellent display performance driven by a pure **DIGITAL** LVDS interface assembled in a compact and slim **LED backlight** unit. This LCD supports 1366(H) x RGB x 768(V) stripe color pixel format and 262,144 colors (RGB 6 bits data) with vivid color image. Its outstanding performances with wide operation temperature range, **-20 ~ 60°C**, brightness at **400 nits**(typ.), and high contrast ratio 500:1 make this monitor very suitable for various applications.

### 2.1 General Applications

- Display terminal for applications of Industrial, Medical, Gaming, HMI, Amusement, Advertisement or more

### 2.2 Main Features

- 16:9 1366 x RGB x 768 Display Aspect Ratio
- Slim & Light weight
- LED Backlight
- High Contrast Ratio
- Pure Digital LVDS (Low Voltage Differential Signaling) Interface
- DE (Data Enable) Mode
- RoHS Compliance
- LED Driver included

### 2.3 General Information

#### 2.3.1 Display Characteristics

Item	Specification	Unit	Note
Display Area (HxV)	344.2 x 195.3	mm	15.6" Diagonal
Driver Element	a-Si TFT Active Matrix	-	-
Number of Pixels (HxV)	1366 x RGB x 768	pixel	WXGA
Pixel Arrangement	R.G.B Vertical Stripe	-	-
Pixel Pitch (HxV)	(0.0863x3) x 0.259	mm	
Viewing Angle (H/V)	90/50	degree	
Signal Interface	Digital RGB 18 bits ( 1 ch LVDS)		262K colors
Display Mode	Normally White	-	-
Surface Treatment	3H Hard Coating, 25% Haze AG	-	-



### 2.3.2 Mechanical Dimensions (Note 1)

Item		Min.	Typ.	Max.	Unit	Note
Dimension	Horizontal		363.9		mm	±0.5 mm
	Vertical		210.0			±0.5 mm
	Depth	-	9.2			+0.5 mm
Weight		-	590		g	±10 g

Note1. The dimension of LED driver is not included.



### 3.0 Absolute Maximum Ratings

#### 3.1 Absolute Ratings of Environment Requirement

Item	Symbol	Min.	Max.	Unit	Note
Storage Temperature	Tstg	-30	+ 70	°C	
Operation Temperature (Ambient Temperature)	Top	-20	+ 60	°C	

**Note (1)** Temperature and relative humidity range are shown in the figure below.

95% RH Max. ( $40^{\circ}\text{C} > T_a$ )

Maximum wet – bulb temperature at  $39^{\circ}\text{C}$  or less. ( $T_a > 40^{\circ}\text{C}$ ) No condensation.

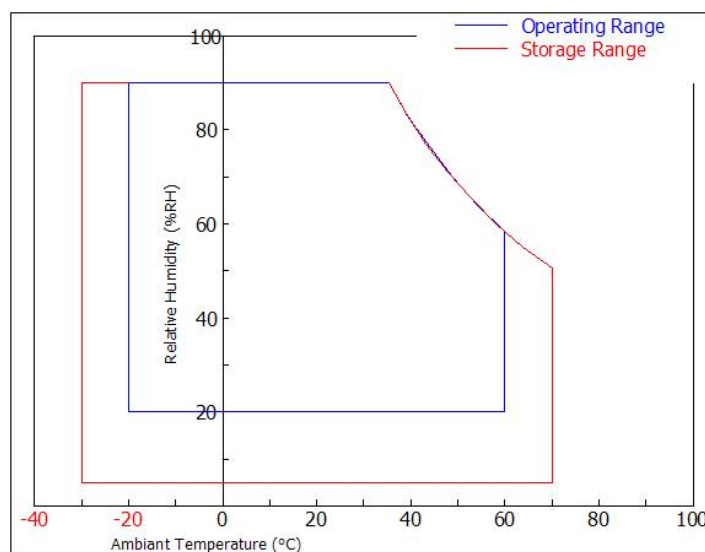

#### 3.2 Electrical Absolute Ratings

##### 3.2.1 TFT-LCD Module

( $T_a = 25 \pm 2^{\circ}\text{C}$ ),  $V_{gg} = \text{GND} = 0\text{V}$ )

Item	SYMBOL	Min.	Max.	UNIT	NOTE
Power Supply Voltage	$V_{DD}$	-0.3	4.0	V	(1),(2)
Input Voltage of Signal	$V_{i1}$	-0.3	$V_{DD} + 0.3$	V	(1),(2)

##### 3.2.2 Backlight Module(LED)

Item	SYMBOL	MIN	MAX	UNIT	NOTE
Input DC Voltage	$V_{BL}$	-	15	V	(1),(2)

**Note (1)** Within operating temperature

**Note (2)** Permanent damage to the device may occur if maximum values are exceeded.

Functional operation should be restricted to the conditions described under normal operating conditions.



## 4.0 Optical Characteristics

The following items are measured under stable conditions in a dark room or equivalent state.

\* Measuring Equipment: BM-5A, PR-650

( $V_{DD}=3.3V$ ,  $f_V=60Hz$ ,  $f_H=48\text{ KHz}$ ,  $T_a=25\pm 2^\circ C$ )

Item	Symbol	Condition	Min.	Typ.	Max.	Unit	Note
Contrast Ratio	CR	At optimized Viewing Angle		500	-	-	(1)(2)(4)
Response Time at 25°C	Falling	$T_F$	$\theta=0^\circ$	Rising + Falling		ms	(3)
	Rising	$T_F$		8	15		
Luminance(center)	$Y_L$			400	-	cd/m <sup>2</sup>	(1)(2)(6)
Viewing Angle	Hor.	$\theta_L$	CR $\geq$ 10 at center point	45	-	Degree	(1)(2)(5)
		$\theta_R$		45	-		
	Ver.	$\theta_H$		15	-		
		$\theta_L$		35	-		

**Note (1)** : Ambient temperature =25°C, and , using the Mode 2 of LED control scheme and  $V_{DIM}=0V$  to get the maximum brightness. To be measured in the dark room.

**Note (2)** : To be measured on the center area of panel with a viewing cone of 1° by Topcon Luminance Meter BM-5, after 30 minutes operation.

**Note (3)** : Definition of response time:

The output signals of photo detector are measured when the input signals are changed from “black” to “white”(falling time) and from “white” to “black”(rising time), respectively.

The response time is defined as the time interval between the 10% and 90% of amplitudes. Refer to figure as below.

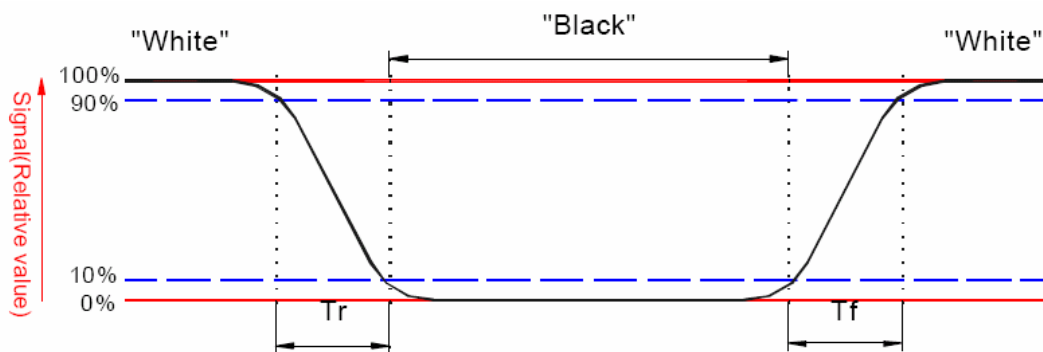



**Note (4)** : Definition of contrast ratio:

Contrast ratio is calculated with the following formula.

$$\text{Contrast ratio (CR)} = \frac{\text{Photo detector output when LCD is at "White" state}}{\text{Photo detector output when LCD is at "Black" state}}$$

**Note (5)** : Definition of viewing angle, Refer to figure as below.

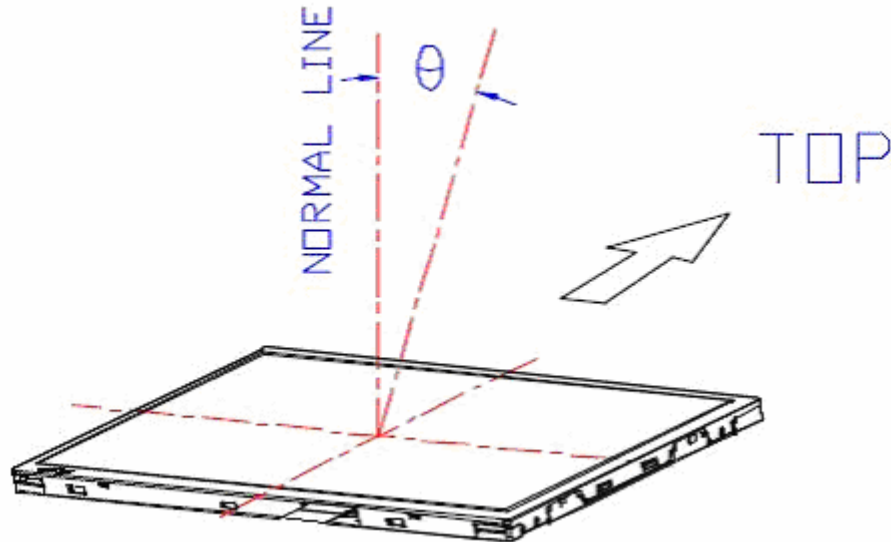

**Note (6)** : Measured at the center area of the panel when all the input terminals of LCD panel are electrically opened.



## 5.0 Electrical Characteristics

### 5.1 AC Timing Characteristics

Signal	Item	Symbol	Min.	Typ.	Max.	Unit	Note
LVDS Clock	Frequency	Fc		77.8		MHz	-
	Period	Tc		12.85		ns	
Vertical Active Display Term	Frame Rate	Fr		60		Hz	
	Total	Tv	776	808	1023	Th	Tv=Tvd+Tvb
	Display	Tvd	768	768	768	Th	-
	Blank	Tvb	Tv-Tvd	40	Tv-Tvd	Th	-
Horizontal Active Display Term	Total	Th	1396	1606	2047	Tc	Th=Thd+Thb
	Display	Thd	1366	1366	1366	Tc	-
	Blank	Thb	Th-Thd	240	Th-Thd	Tc	-

### 5.2 DC Characteristics

#### 5.2.1 TFT-LCD Module

Item	Symbol	Min.	Typ.	Max.	Unit	Note	
Power Supply	V <sub>DD</sub>	3.0	3.3	3.6	V	(1)	
	I <sub>DD</sub>	White	-	(250)	-	mA	V <sub>DD</sub> = 3.3
		Black	-	(400)	-	mA	
Permissive Input Ripple Voltage of V <sub>DD</sub>	V <sub>RF</sub>	-	-	100	mV <sub>P-P</sub>	V <sub>DD</sub> = 3.3V	
LVDS Differential Input Voltage	V <sub>id</sub>	-100		100	mV		
LVDS Common Input Voltage	V <sub>ic</sub>		1.2		V		

**Note (1)** VDD Power-On Condition for TFT-LCD module :

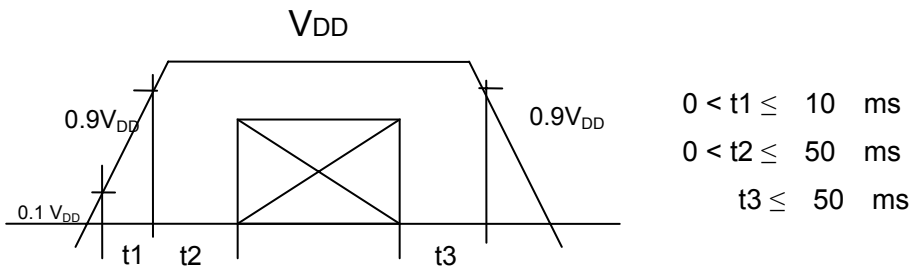



### 5.2.2 Backlight Unit & LED Driver

Item	Symbol	Min.	Typ.	Max.	Unit	Note
Power Supply	$V_{BL}$	10.8	12	13.2	V	Note 1
	$I_{BL}$		0.96		Amp	Note 2

**Note 1 :**  $V_{BL}$  Power-On Condition for LED driver :

**Please make sure the control signals for LED driver must arrive after the power supply of LED driver,  $V_{BL}$ .**

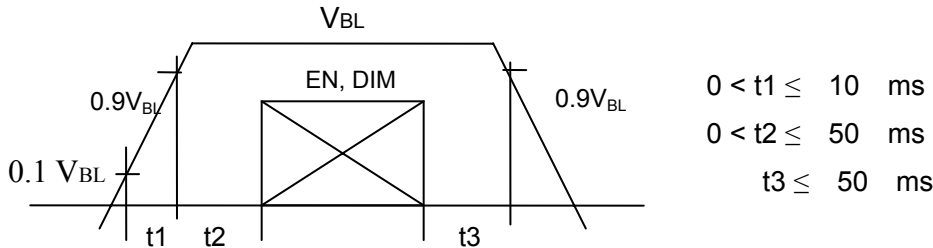

**Note 2 :**  $V_{BL} = 12V$ , using the Mode 2 of LED control scheme and  $V_{DIM} = 0V$  to get the maximum brightness.

## 5.3 Input Terminal Pin Assignment

### 5.3.1 Signal Input Interface

JAE Connector: 30 pin, 1mm pitch JAE-FI-XB30SL-HF10

Mating Connector : JAE JAE-FI-X30H, or equivalent

Pin No	Symbol	Description	Remark
1	GND	Ground	-
2	$V_{DD}$	Power Supply + 3.3V	-
3	$V_{DD}$	Power Supply + 3.3V	-
4	$V_{EDID}$	DDC 3.3V Power	-
5	NC	No-Connection	
6	$CLK_{EDID}$	DDC Clock	
7	$Data_{EDID}$	DDC Data	-
8	RxIN0-	LVDS receiver signal channel 0	R0~R5, G0
9	RxIN0+		
10	GND	Ground	-
11	RxIN1-	LVDS receiver signal channel 1	G1~G5, B0, B1
12	RxIN1+		
13	GND	Ground	-
14	$CLKI2-$	LVDS receiver signal channel 2	B2~B5, DE, Hsync, Vsync
15	$CLKI2+$		
16	GND	Ground	-
17	$CLKIN-$	LVDS receiver signal clock	LVDS Level



18	CLKIN+		Colck
19	GND	Ground	
20	GND	Ground	-
21	NC	No-Connection	
22	GND	Ground	
23	NC	No-Connection	
24	NC	No-Connection	
25	GND	Ground	
26	NC	No-Connection	
27	NC	No-Connection	
28	GND	Ground	
29	NC	No-Connection	
30	NC	No-Connection	

### 5.3.2 LED Driver Unit

Connector: ACES 88290-0601 pitch 2.0mm 6 pins CN

Or JST S6B-PH-K-S

#### Mode 1 :

Matching Connector : ACES 86809-0600 CN

Pin No.	Symbol	Description	Remark
1	V <sub>BL</sub>	Power Supply for LED Driver	
2	V <sub>BL</sub>	Power Supply for LED Driver	
3	EN	LED Enable & Dimming Control Input	Note 1
4	DIM	Connect this pin to GND at this mode	Note 2
5	GND	Ground Pin for LED Driver	
6	GND	Ground Pin for LED Driver	

Note 1 : The “Enable & Dimming Control” of the LED driver shares the same pinning.

The LED backlight will turn on when the input voltage of this pin exceeds +0.6V.

The LED current/brightness will be adjustable by applying an analog voltage between +0.8 ~ +1.4V(Max. Brightness).

Note 2: The “DIM” pin should be connected to GND in order to get the full brightness.

#### Mode 2:

Pin No.	Symbol	Description	Remark
1	V <sub>BL</sub>	Power Supply for LED Driver	
2	V <sub>BL</sub>	Power Supply for LED Driver	
3	EN	LED Enable Control Input	Note 1
4	DIM	Dimming Control Input	Note 2
5	GND	Ground Pin for LED Driver	
6	GND	Ground Pin for LED Driver	



Note 1 : Disable  $V_{EN} < 0.6$  V, Enable  $V_{EN} > 1.8$  V

Note 2 : Max Brightness  $V_{DIM} : 0V$ , Min Brightness  $V_{DIM} : 2.2V$  (  $\approx 0$  Nit )

**Mode 3:**

Pin No.	Symbol	Description	Remark
1	$V_{BL}$	Power Supply for LED Driver	
2	$V_{BL}$	Power Supply for LED Driver	
3	EN	PWM Control Pulse Input	Note 1, 2
4	DIM	Connect this pin to GND at this mode	Note 3
5	GND	Ground Pin for LED Driver	
6	GND	Ground Pin for LED Driver	

Note 1: Valley of PWM Pulse  $V_{PWM} < 0.6$  V, Peak of PWM Pulse  $V_{PWM} > 1.8$  V

Note 2: The frequency of each completed PWM cycle: 100~300 Hz

Note 3: The “DIM” pin should be connected to GND in order to get the full brightness.

**5.3.4 Color Data Reference**

The below table is about input signal, Basic display colors and gray scale of each color.

0 : Low Level Voltage      1 : High Level Voltage

Each basic color can be displayed in 64 gray scales from 6 bit data signals. With the combination of total 18 bit data signals, the 262,144 color display can be achieved on the screen.

- Please refer to the next page



	Colors & Gray Scale	Data Signal																		
		Gray Scale	R0	R1	R2	R3	R4	R5	G0	G1	G2	G3	G4	G5	B0	B1	B2	B3	B4	B5
Basic Color	Black	-	0	0	0	0	0	0	0	0	0	0	0	0	0	0	0	0	0	0
	Blue	-	0	0	0	0	0	0	0	0	0	0	0	0	1	1	1	1	1	1
	Green	-	0	0	0	0	0	0	1	1	1	1	1	1	0	0	0	0	0	0
	Cyan	-	0	0	0	0	0	0	1	1	1	1	1	1	1	1	1	1	1	1
	Red	-	1	1	1	1	1	1	0	0	0	0	0	0	0	0	0	0	0	0
	Magenta	-	1	1	1	1	1	1	0	0	0	0	0	0	1	1	1	1	1	1
	Yellow	-	1	1	1	1	1	1	1	1	1	1	1	1	0	0	0	0	0	0
	White	-	1	1	1	1	1	1	1	1	1	1	1	1	1	1	1	1	1	1
Gray Scale of Red	Black	GS0	0	0	0	0	0	0	0	0	0	0	0	0	0	0	0	0	0	0
	↑	GS1	1	0	0	0	0	0	0	0	0	0	0	0	0	0	0	0	0	0
	Darker	GS2	0	1	0	0	0	0	0	0	0	0	0	0	0	0	0	0	0	0
	↑	↓				↓					↓						↓			
	↓	↓									↓						↓			
	Brighter	GS61	1	0	1	1	1	1	0	0	0	0	0	0	0	0	0	0	0	0
	↓	GS62	0	1	1	1	1	1	0	0	0	0	0	0	0	0	0	0	0	0
	Red	GS63	1	1	1	1	1	1	0	0	0	0	0	0	0	0	0	0	0	0
Gray Scale of Green	Black	GS0	0	0	0	0	0	0	0	0	0	0	0	0	0	0	0	0	0	0
	↑	GS1	0	0	0	0	0	0	1	0	0	0	0	0	0	0	0	0	0	0
	Darker	GS2	0	0	0	0	0	0	0	1	0	0	0	0	0	0	0	0	0	0
	↑	↓				↓														
	↓	↓				↓														
	Brighter	GS61	0	0	0	0	0	0	1	0	1	1	1	1	0	0	0	0	0	0
	↓	GS62	0	0	0	0	0	0	0	1	1	1	1	1	0	0	0	0	0	0
	Green	GS63	0	0	0	0	0	0	1	1	1	1	1	1	0	0	0	0	0	0
Gray Scale of Blue	Black	GS0	0	0	0	0	0	0	0	0	0	0	0	0	0	0	0	0	0	0
	↑	GS1	0	0	0	0	0	0	0	0	0	0	0	0	1	0	0	0	0	0
	Darker	GS2	0	0	0	0	0	0	0	0	0	0	0	0	0	1	0	0	0	0
	↑	↓																		
	↓	↓																		
	Brighter	GS61	0	0	0	0	0	0	0	0	0	0	0	0	1	0	1	1	1	1
	↓	GS62	0	0	0	0	0	0	0	0	0	0	0	0	0	1	1	1	1	1
	Blue	GS63	0	0	0	0	0	0	0	0	0	0	0	0	1	1	1	1	1	1

# 5.4 Input Timing Chart

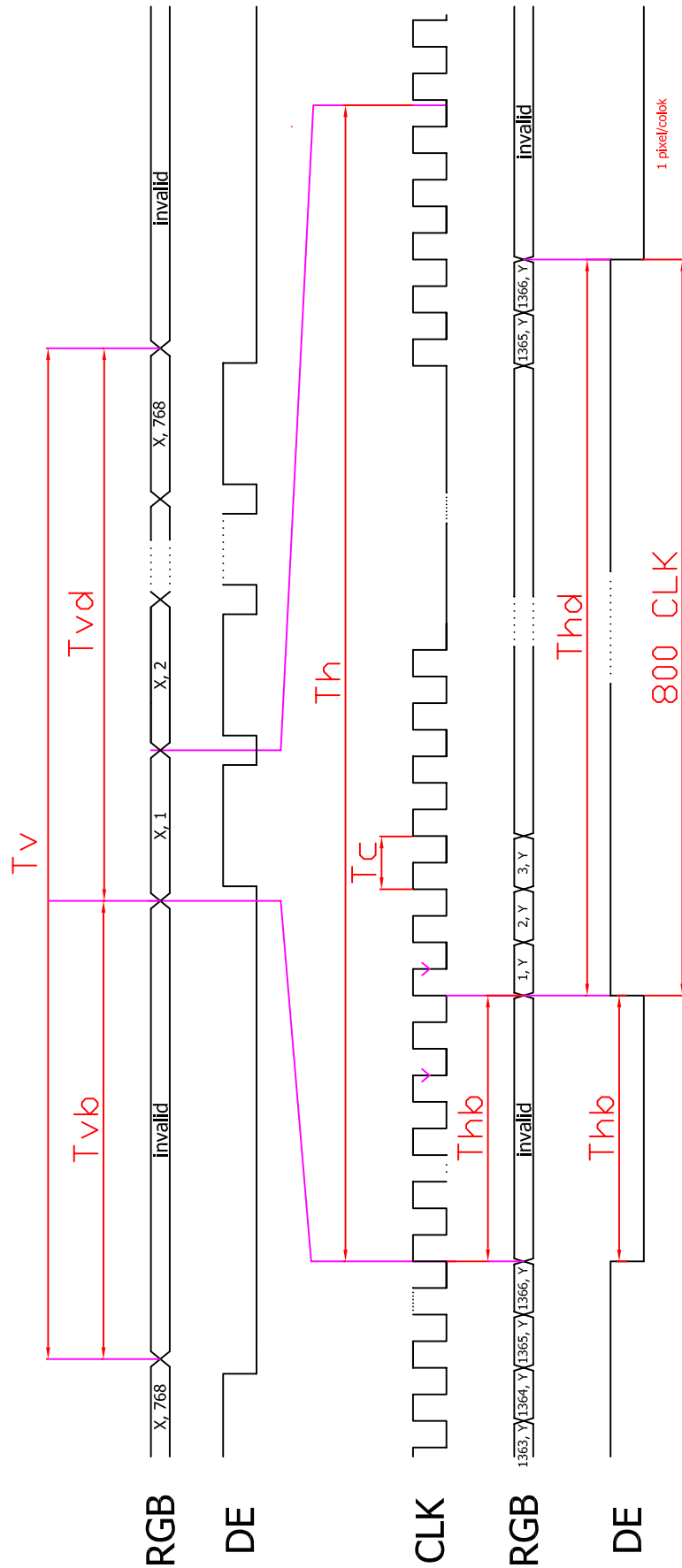



## 6.0 Pixel Format Image

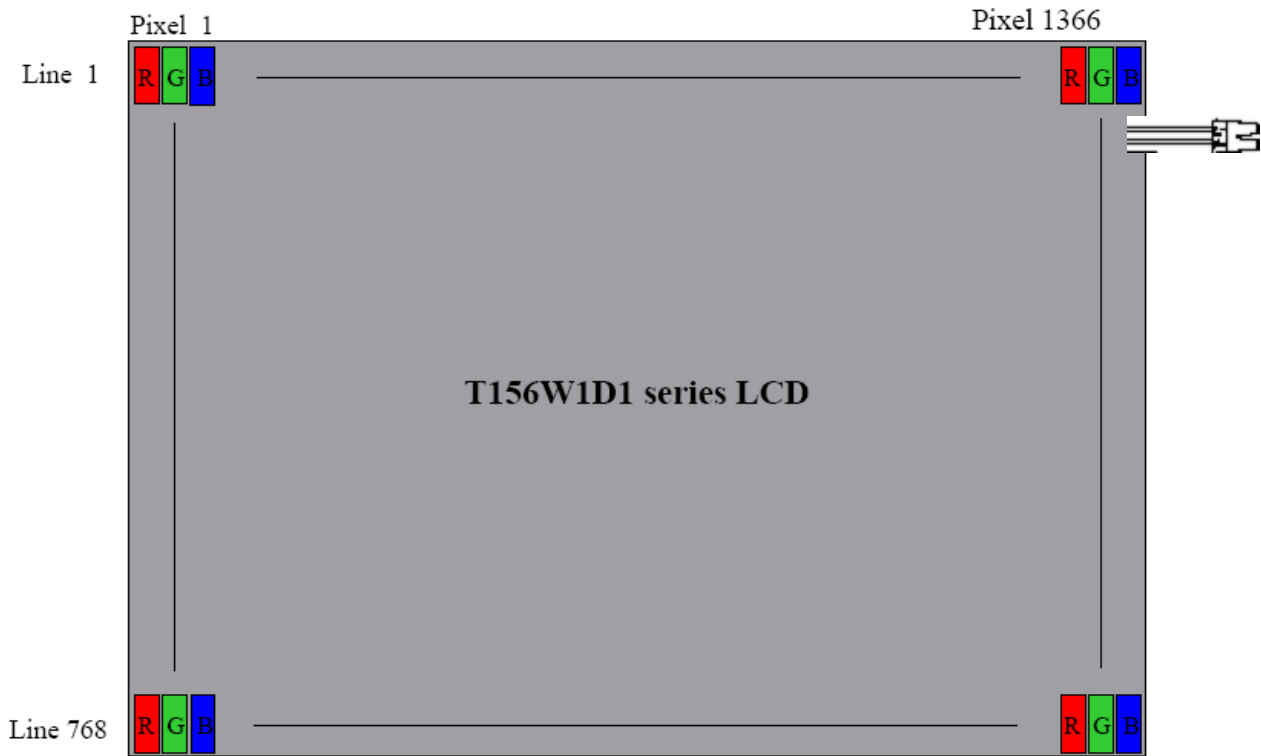

## 7.0 Display Outline Dimensions

### 7.1 Monitor Outline Dimensions

- Please refer to the next page



REV	EQ NUMBER	DESCRIPTION	DATE
1	APPROVED	APPROVED	

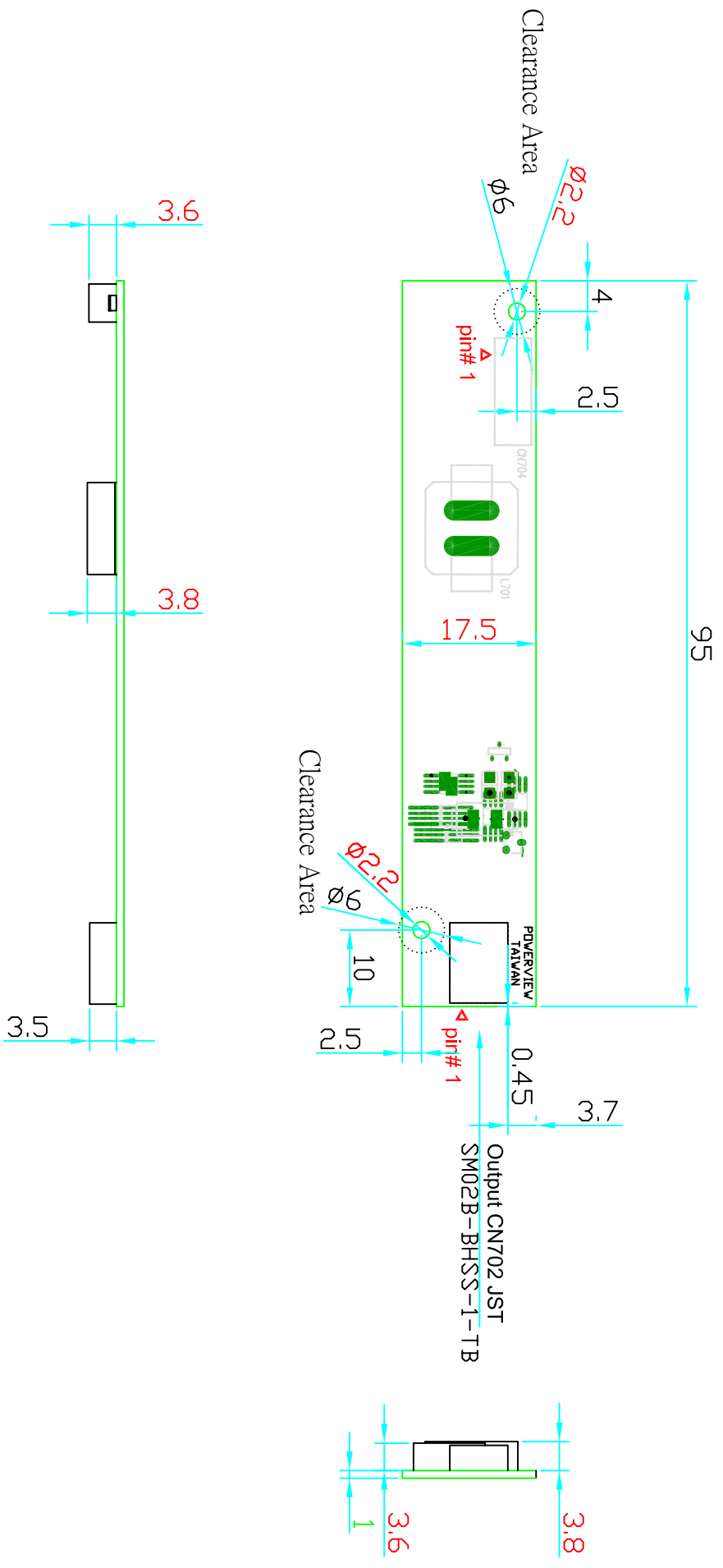

GENERAL INFORMATION		MATERIAL		DRAWING INFORMATION	
DATE	11/17/21	3rd ANGLE	LD156W10	SCALE	1:1
PROJECT	DR0236200156-00	DATE	11/17/21	DESIGNED BY	Tim Chung
REV	1	APPROVED BY		CHECKED BY	
REV	2	APPROVED BY		CHECKED BY	

POVERVIEW DISPLAY CORPORATION All Rights Reserved

See notes

FINISH

APPROVED

DESIGNED

REVISIONS

A B C D E F

1 2 3 4 5 6 7 8 9 10 11 12



## 8.0 Labeling, Packaging & Others

### \* Labeling

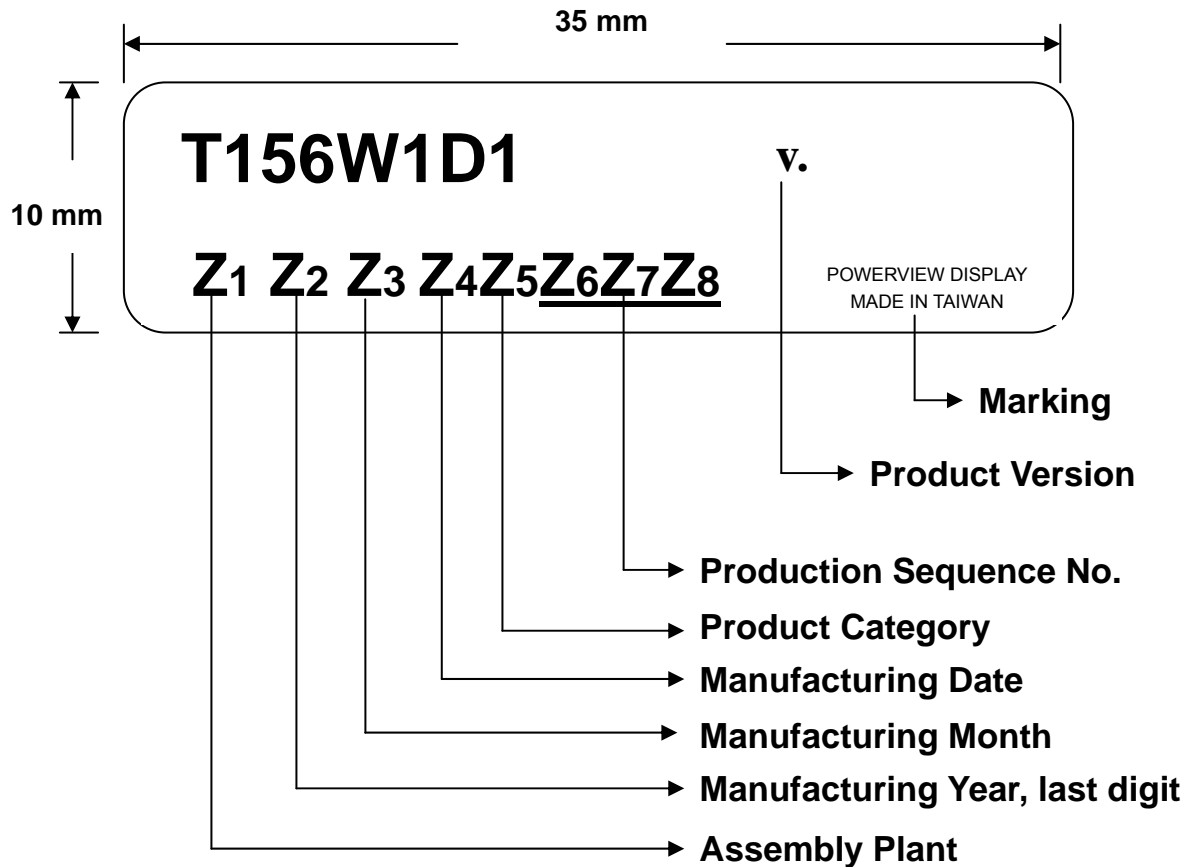

### \* Packaging

- TBD



POWERVIEW DISPLAY CORP.  
銳視光電股份有限公司

To be updated



## 9.0 General Notice

### 9.1 Reliability Test Items (Note 2)

No.	Test Items	Conditions	Remark
1	High Temperature Storage	Ta= + 70°C                      240 Hrs	
2	Low Temperature Storage	Ta= - 30°C                      240 Hrs	
3	High Temperature Operation	Ta= + 60°C                      240 Hrs	
4	Low Temperature Operation	Ta= - 20°C                      240 Hrs	
5	High Temperature and High Humidity	Tp= 45°C, 90%RH              240 Hrs	operation
6	Heat Shock	-30~70°C/200 cycles 1Hr/cycle	Non-operation
7	Electrostatic discharge	±200V, 200pF(0Ω), once for each terminal	Non-operation
8	Vibration	Frequency range : 8~33.3 Hz Stoke                      : 1.3mm Sweep                      : 2.9G, 33.3~400Hz Cycle                      : 15 minutes 2 hours for each direction of X,Z 4 hours for Y direction	JIS C7021, A-10 Condition A
9	Mechanical Shock	100G, 6ms, ±X±Y±Z 3 times for each direction	JIS C7021, A-7 Condition C
10	Vibration (with carton)	Random vibration : 0.015G <sup>2</sup> /Hz from 5~200Hz -6dB/octave from 200~500Hz	IEC 68-34
11	Drop (with carton)	Height : 60 cm 1 corner, 3 edges, 6 surfaces	JIS Z0202

Note1: Ta: Ambient temperature.

Note 2: In the standard conditions, there is not display function NG issue occurred. All the cosmetic specification is judged before the reliability stress.



## 9.2 Storage, Operation & Others

- (a) Do not leave the panel in high temperature, and high humidity for a long time.  
It is highly recommended to store the module with temperature from 0 to 35°C and relative humidity of less than 70%.
- (b) Do not store the TFT-LCD module in direct sunlight.
- (c) The module shall be stored in a dark place. It is prohibited to apply sunlight or fluorescent light during the store.
- (d) Do not connect, disconnect the module in the "Power On" condition.
- (e) Power supply should always be turned on/off by the item 3.2 "Electrical Absolute Ratings"
- (f) The liquid-crystal is deteriorated by ultraviolet rays. Do not leave it in direct sunlight and strong ultraviolet rays for many hours.
- (g) Avoid condensation of water. It may result in improper operation or disconnection of electrode.
- (h) Do not exceed the absolute maximum rating value. (the supply voltage variation, input voltage variation, variation in part contents and environmental temperature, and so on) Otherwise the panel may be damaged.
- (i) If the panel displays the same pattern continuously for a long period of time, it can be the situation when the image "Sticks" to the screen.
- (j) This panel has its circuitry FPC on the bottom side and should be handled carefully in order not to be stressed.