



# TFT-LCD MONITOR

## Product Information

**Temporary**

**MODEL NO. : T156W1D1 v.1**

**Date : 2009.01.13 Rev. 0.1**

**Prepared by : Nicholas Shih**

*Nicholas Shih, Engineer, Product Development Div.*

**Approved by : Jackey Chien**

*Jackey Chen, Director,, Product Development Div.*

This TFT LCD Monitor is distributed by:



Display Solution AG  
Talhofstraße 32a  
D-82205 Gilching  
GERMANY  
Fon +49 (0)8105 / 73 403 - 0  
Fax +49 (0)8105 / 73 403 - 79  
E-Mail: info@display-solution.com  
Internet: www.display-solution.com

This product specification is subject to change without any notice.



## Records of Revision

| Date      | Rev. No. | Summary     | Page |
|-----------|----------|-------------|------|
| 2009.1.13 | 0.1      | First Issue | 1    |
|           |          |             |      |



| <b>Contents</b>                                 | <b>Page</b> |
|---|-------------|
| <b>1.0 Handling Precautions</b>                 | <b>4</b>    |
| <b>2.0 General Description</b>                  | <b>5</b>    |
| 2.1 General Application                         | 5           |
| 2.2 Main Features                               | 5           |
| 2.3 General Information                         | 5           |
| 2.3.1 Display Characteristics                   | 5           |
| 2.3.2 Mechanical Dimensions                     | 6           |
| <b>3.0 Absolute Maximum Ratings</b>             | <b>7</b>    |
| 3.1 Absolute Ratings of Environment Requirement | 7           |
| 3.2 Electrical Absolute Ratings                 | 7           |
| 3.2.1 TFT-LCD Module                            | 7           |
| 3.2.2 Backlight Module(LED)                     | 7           |
| <b>4.0 Optical Characteristics</b>              | <b>8</b>    |
| <b>5.0 Electrical Characteristics</b>           | <b>10</b>   |
| 5.1 AC Timing Characteristics                   | 10          |
| 5.2 DC Characteristics                          | 10          |
| 5.2.1 TFT-LCD Module                            | 10          |
| 5.2.2 Backlight Unit & LED Driver               | 11          |
| 5.3 Input Terminal Pin Assignment               | 11          |
| 5.3.1 Signal Input Interface                    | 11          |
| 5.3.2 LED Driver Unit                           | 12          |
| 5.3.3 Scanning Direction                        | 12          |
| 5.3.4 Color Data Reference                      | 13          |
| 5.4 Input Timing Chart                          | 15          |
| <b>6.0 Pixel Format Image</b>                   | <b>16</b>   |
| <b>7.0 Display Outline Dimensions</b>           | <b>16</b>   |
| <b>8.0 Labeling, Packaging &amp; Others</b>     | <b>19</b>   |
| <b>9.0 General Notices</b>                      | <b>21</b>   |
| 9.1 Reliability Test Item                       | 21          |
| 9.2 Storage, Operation & Others                 | 22          |



## 1.0 Handling Precaution

- 1.) Handle with care. Pay attention not to press or scratch the surface of the monitor, especially the polarizer. Do not twist or bend the monitor. It may cause un-recoverable damage.
- 2.) Do not drop or bump the monitor since this monitor contains fragile glass components. Breakage of this monitor might cause leakage of the liquid crystal sealed inside the glasses. Do not touch the liquid crystal liquid in case of leakage. **Flush with massive water immediately in case of contact with your skin by liquid crystal fluid and call for doctor for immediate medical treatment.**
- 3.) Be sure to turn off power supply while plug or un-plug the power input connector.
- 4.) Clean up the polarizer only with soft solvent if necessary. The desirable cleaners are water, IPA(Isopropyl Alcohol) or Hexane. Do not use Ketone type materials (ex. Acetone), Ethyl alcohol, toluene, Ethyl acid or Methyl chloride. It will permanently damage the polarizer due to chemical reaction. 5.) Wipe off fluid drop immediately to prevent from possible discoloration or spots on the polarizer.
- 6.) Do not twist nor bend the monitor structure, even momentarily. Bending or twisting torque may likely damage the internal components of the monitor.
- 7.) Protect the monitor from static environment to prevent from damage to the CMOS gate array IC.



## 2.0 General Description

T156W1D1 v.1 is a 15.6 inch (TRUE 16:9 wide aspect ratio) color active matrix TFT LCD monitor with excellent display performance driven by a pure **DIGITAL** LVDS interface assembled in a compact and slim **LED backlight** unit. This LCD supports 1366(H) x RGB x 768(V) stripe color pixel format and 262,144 colors (RGB 6 bits data) with vivid color image. Its outstanding performances with wide operation temperature range, **-20 ~ 60°C**, brightness at **800 nits**(typ.), and high contrast ratio 500:1 make this monitor very suitable for various applications.

### 2.1 General Applications

- Display terminal for applications of Industrial, Medical, Gaming, HMI, Amusement, Advertisement or more

### 2.2 Main Features

- 16:9 1366 x RGB x 768 Display Aspect Ratio
- Slim & Light weight
- Sunlight Readable Brightness 800 nits
- LED Backlight
- High Contrast Ratio
- Pure Digital LVDS (Low Voltage Differential Signaling) Interface
- DE (Data Enable) Mode
- RoHS Compliance
- LED Driver included

### 2.3 General Information

#### 2.3.1 Display Characteristics

| Item                   | Specification                    | Unit   | Note           |
|------------------------|----------------------------------|--------|----------------|
| Display Area (HxV)     | 344.2 x 195.3                    | mm     | 15.6" Diagonal |
| Driver Element         | a-Si TFT Active Matrix           | -      | -              |
| Number of Pixels (HxV) | 1366 x RGB x 768                 | pixel  | WXGA           |
| Pixel Arrangement      | R.G.B Vertical Stripe            | -      | -              |
| Pixel Pitch (HxV)      | (0.0863x3) x 0.259               | mm     |                |
| Viewing Angle (H/V)    | 90/50                            | degree |                |
| Signal Interface       | Digital RGB 18 bits ( 1 ch LVDS) |        | 262K colors    |
| Display Mode           | Normally White                   | -      | -              |
| Surface Treatment      | 3H Hard Coating, 25% Haze AG     | -      | -              |



### 2.3.2 Mechanical Dimensions (Note 1)

| Item      |            | Min. | Typ.  | Max. | Unit | Note    |
|-----------|------------|------|-------|------|------|---------|
| Dimension | Horizontal |      | 363.9 |      | mm   | ±0.5 mm |
|           | Vertical   |      | 210.0 |      |      | ±0.5 mm |
|           | Depth      | -    | 9.2   |      |      | +0.5 mm |
| Weight    |            | -    | 590   |      | g    | ±10 g   |

Note1. The dimension of LED driver is not included.



### 3.0 Absolute Maximum Ratings

#### 3.1 Absolute Ratings of Environment Requirement

| Item   | Symbol | Min. | Max. | Unit | Note |
|--|--------|------|------|------|------|
| Storage Temperature                            | Tstg   | -30  | + 70 | °C   |      |
| Operation Temperature<br>(Ambient Temperature) | Top    | -20  | + 60 | °C   |      |

**Note (1)** Temperature and relative humidity range are shown in the figure below.

95% RH Max. ( $40^{\circ}\text{C} > T_a$ )

Maximum wet – bulb temperature at  $39^{\circ}\text{C}$  or less. ( $T_a > 40^{\circ}\text{C}$ ) No condensation.

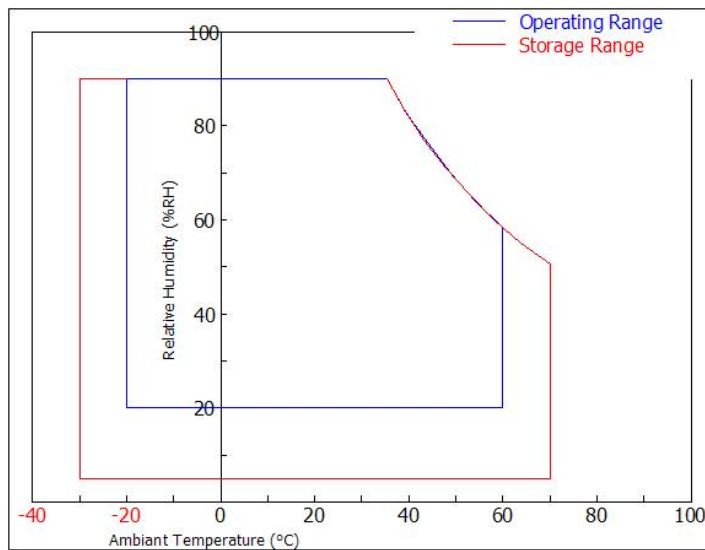

#### 3.2 Electrical Absolute Ratings

##### 3.2.1 TFT-LCD Module

( $T_a = 25 \pm 2^{\circ}\text{C}$ ),  $V_{gg} = \text{GND} = 0\text{V}$ )

| Item                    | SYMBOL   | Min. | Max.           | UNIT | NOTE    |
|-------------------------|----------|------|----------------|------|---------|
| Power Supply Voltage    | $V_{DD}$ | -0.3 | 4.0            | V    | (1),(2) |
| Input Voltage of Signal | $V_{i1}$ | -0.3 | $V_{DD} + 0.3$ | V    | (1),(2) |

##### 3.2.2 Backlight Module(LED)

| Item             | SYMBOL   | MIN | MAX | UNIT | NOTE    |
|------------------|----------|-----|-----|------|---------|
| Input DC Voltage | $V_{BL}$ | -   | 15  | V    | (1),(2) |

**Note (1)** Within operating temperature

**Note (2)** Permanent damage to the device may occur if maximum values are exceeded.

Functional operation should be restricted to the conditions described under normal operating conditions.



## 4.0 Optical Characteristics

The following items are measured under stable conditions in a dark room or equivalent state.

\* Measuring Equipment: BM-5A, PR-650

( $V_{DD}=3.3V$ ,  $f_V=60Hz$ ,  $f_H=48\text{ KHz}$ ,  $T_a=25\pm 2^\circ C$ )

| Item                  | Symbol  | Condition                  | Min.                         | Typ.             | Max. | Unit              | Note      |
|-----------------------|---------|----------------------------|------------------------------|------------------|------|-------------------|-----------|
| Contrast Ratio        | CR      | At optimized Viewing Angle |                              | 500              | -    | -                 | (1)(2)(4) |
| Response Time at 25°C | Falling | $T_F$                      | $\theta=0^\circ$             | Rising + Falling |      | ms                | (3)       |
|                       | Rising  | $T_F$                      |                              | 8                | 15   |                   |           |
| Luminance(center)     | $Y_L$   |                            |                              | 800              | -    | cd/m <sup>2</sup> | (1)(2)(6) |
| Viewing Angle         | Hor.    | $\theta_L$                 | CR $\geq$ 10 at center point | 45               | -    | Degree            | (1)(2)(5) |
|                       |         | $\theta_R$                 |                              | 45               | -    |                   |           |
|                       | Ver.    | $\theta_H$                 |                              | 15               | -    |                   |           |
|                       |         | $\theta_L$                 |                              | 35               | -    |                   |           |

**Note (1)** : Ambient temperature =25°C, and , using the Mode 2 of LED control scheme and  $V_{DIM}=0V$  to get the maximum brightness. To be measured in the dark room.

**Note (2)** : To be measured on the center area of panel with a viewing cone of 1° by Topcon Luminance Meter BM-5, after 30 minutes operation.

**Note (3)** : Definition of response time:

The output signals of photo detector are measured when the input signals are changed from “black” to “white”(falling time) and from “white” to “black”(rising time), respectively.

The response time is defined as the time interval between the 10% and 90% of amplitudes. Refer to figure as below.

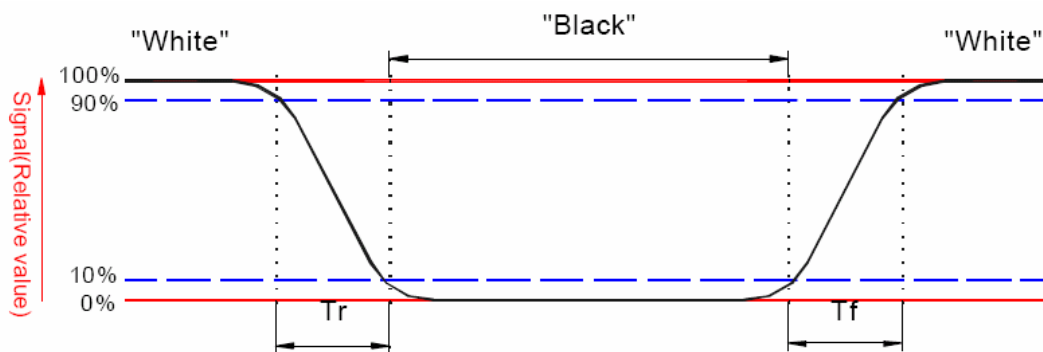



**Note (4)** : Definition of contrast ratio:

Contrast ratio is calculated with the following formula.

$$\text{Contrast ratio (CR)} = \frac{\text{Photo detector output when LCD is at "White" state}}{\text{Photo detector output when LCD is at "Black" state}}$$

**Note (5)** : Definition of viewing angle, Refer to figure as below.

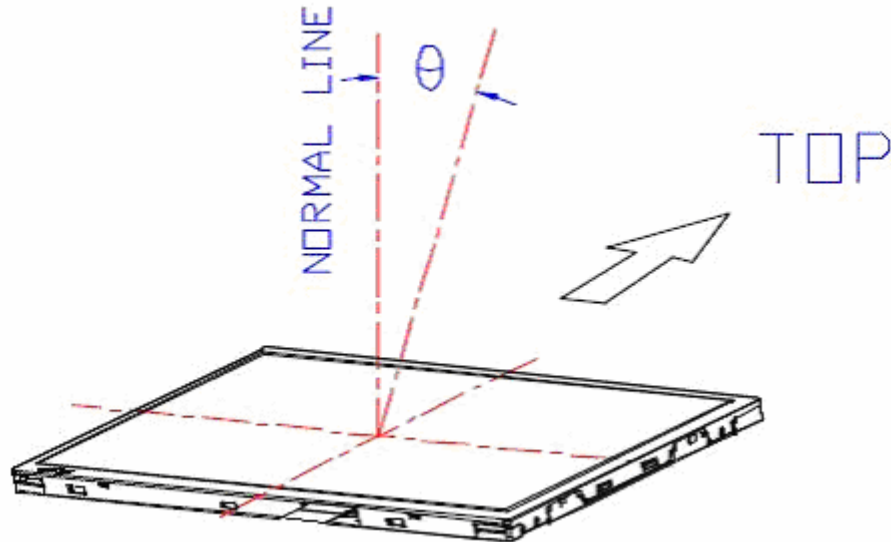

**Note (6)** : Measured at the center area of the panel when all the input terminals of LCD panel are electrically opened.



## 5.0 Electrical Characteristics

### 5.1 AC Timing Characteristics

| Signal                         | Item       | Symbol | Min.   | Typ.  | Max.   | Unit | Note       |
|--------------------------------|------------|--------|--------|-------|--------|------|------------|
| LVDS Clock                     | Frequency  | Fc     |        | 77.8  |        | MHz  | -          |
|                                | Period     | Tc     |        | 12.85 |        | ns   |            |
| Vertical Active Display Term   | Frame Rate | Fr     |        | 60    |        | Hz   |            |
|                                | Total      | Tv     | 776    | 808   | 1023   | Th   | Tv=Tvd+Tvb |
|                                | Display    | Tvd    | 768    | 768   | 768    | Th   | -          |
|                                | Blank      | Tvb    | Tv-Tvd | 40    | Tv-Tvd | Th   | -          |
| Horizontal Active Display Term | Total      | Th     | 1396   | 1606  | 2047   | Tc   | Th=Thd+Thb |
|                                | Display    | Thd    | 1366   | 1366  | 1366   | Tc   | -          |
|                                | Blank      | Thb    | Th-Thd | 240   | Th-Thd | Tc   | -          |

## 5.2 DC Characteristics

### 5.2.1 TFT-LCD Module

| Item   | Symbol          | Min.  | Typ. | Max.  | Unit              | Note                  |                       |
|--|-----------------|-------|------|-------|-------------------|-----------------------|-----------------------|
| Power Supply                                       | V <sub>DD</sub> | 3.0   | 3.3  | 3.6   | V                 | (1)                   |                       |
|  | I <sub>DD</sub> | White | -    | (250) | -                 | mA                    | V <sub>DD</sub> = 3.3 |
|  |                 | Black | -    | (400) | -                 | mA                    |                       |
| Permissive Input Ripple Voltage of V <sub>DD</sub> | V <sub>RF</sub> | -     | -    | 100   | mV <sub>P-P</sub> | V <sub>DD</sub> =3.3V |                       |
| LVDS Differential Input Voltage                    | V <sub>id</sub> | -100  |      | 100   | mV                |                       |                       |
| LVDS Common Input Voltage                          | V <sub>ic</sub> |       | 1.2  |       | V                 |                       |                       |

**Note (1)** VDD Power-On Condition for TFT-LCD module :

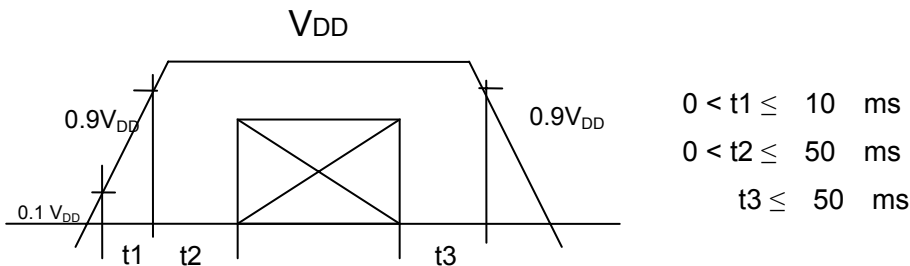



### 5.2.2 Backlight Unit & LED Driver

| Item         | Symbol   | Min. | Typ. | Max. | Unit | Note   |
|--------------|----------|------|------|------|------|--------|
| Power Supply | $V_{BL}$ | 10.8 | 12   | 13.2 | V    | Note 1 |
|              | $I_{BL}$ |      | 1.92 |      | Amp  | Note 2 |

**Note 1 :**  $V_{BL}$  Power-On Condition for LED driver :

**Please make sure the control signals for LED driver must arrive after the power supply of LED driver,  $V_{BL}$ .**

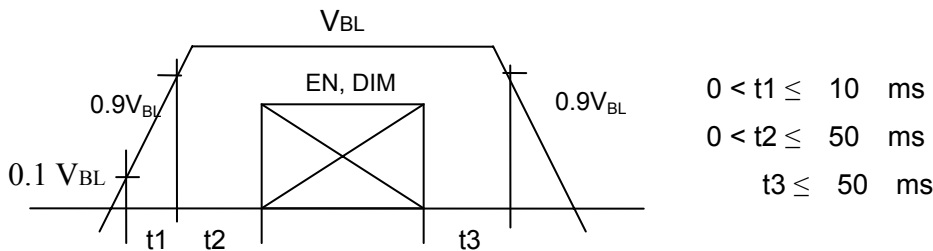

**Note 2 :**  $V_{BL} = 12V$ , using the Mode 2 of LED control scheme and  $V_{DIM} = 0V$  to get the maximum brightness.

## 5.3 Input Terminal Pin Assignment

### 5.3.1 Signal Input Interface

JAE Connector: 30 pin, 1mm pitch JAE-FI-XB30SL-HF10

Mating Connector : JAE JAE-FI-X30H, or equivalent

| Pin No | Symbol        | Description                    | Remark                  |
|--------|---------------|--------------------------------|-------------------------|
| 1      | GND           | Ground                         | -                       |
| 2      | $V_{DD}$      | Power Supply + 3.3V            | -                       |
| 3      | $V_{DD}$      | Power Supply + 3.3V            | -                       |
| 4      | $V_{EDID}$    | DDC 3.3V Power                 | -                       |
| 5      | NC            | No-Connection                  |                         |
| 6      | $CLK_{EDID}$  | DDC Clock                      |                         |
| 7      | $Data_{EDID}$ | DDC Data                       | -                       |
| 8      | RxIN0-        | LVDS receiver signal channel 0 | R0~R5, G0               |
| 9      | RxIN0+        |                                |                         |
| 10     | GND           | Ground                         | -                       |
| 11     | RxIN1-        | LVDS receiver signal channel 1 | G1~G5, B0, B1           |
| 12     | RxIN1+        |                                |                         |
| 13     | GND           | Ground                         | -                       |
| 14     | CLKI2-        | LVDS receiver signal channel 2 | B2~B5, DE, Hsync, Vsync |
| 15     | CLKI2+        |                                |                         |
| 16     | GND           | Ground                         | -                       |
| 17     | CLKIN-        | LVDS receiver signal clock     | LVDS Level              |



|    |        |               |       |
|----|--------|---------------|-------|
| 18 | CLKIN+ |               | Colck |
| 19 | GND    | Ground        |       |
| 20 | GND    | Ground        | -     |
| 21 | NC     | No-Connection |       |
| 22 | GND    | Ground        |       |
| 23 | NC     | No-Connection |       |
| 24 | NC     | No-Connection |       |
| 25 | GND    | Ground        |       |
| 26 | NC     | No-Connection |       |
| 27 | NC     | No-Connection |       |
| 28 | GND    | Ground        |       |
| 29 | NC     | No-Connection |       |
| 30 | NC     | No-Connection |       |

### 5.3.2 LED Driver Unit

Connector: ACES 88290-0601 pitch 2.0mm 6 pins CN

Or JST S6B-PH-K-S

#### Mode 1 :

Matching Connector : ACES 86809-0600 CN

| Pin No. | Symbol          | Description                          | Remark |
|---------|-----------------|--------------------------------------|--------|
| 1       | V <sub>BL</sub> | Power Supply for LED Driver          |        |
| 2       | V <sub>BL</sub> | Power Supply for LED Driver          |        |
| 3       | EN              | LED Enable & Dimming Control Input   | Note 1 |
| 4       | DIM             | Connect this pin to GND at this mode | Note 2 |
| 5       | GND             | Ground Pin for LED Driver            |        |
| 6       | GND             | Ground Pin for LED Driver            |        |

Note 1 : The “Enable & Dimming Control” of the LED driver shares the same pinning.

The LED backlight will turn on when the input voltage of this pin exceeds +0.6V.

The LED current/brightness will be adjustable by applying an analog voltage between +0.8 ~ +1.4V(Max. Brightness).

Note 2: The “DIM” pin should be connected to GND in order to get the full brightness.

#### Mode 2:

| Pin No. | Symbol          | Description                 | Remark |
|---------|-----------------|-----------------------------|--------|
| 1       | V <sub>BL</sub> | Power Supply for LED Driver |        |
| 2       | V <sub>BL</sub> | Power Supply for LED Driver |        |
| 3       | EN              | LED Enable Control Input    | Note 1 |
| 4       | DIM             | Dimming Control Input       | Note 2 |
| 5       | GND             | Ground Pin for LED Driver   |        |
| 6       | GND             | Ground Pin for LED Driver   |        |



Note 1 : Disable  $V_{EN} < 0.6\text{ V}$ , Enable  $V_{EN} > 1.8\text{ V}$

Note 2 : Max Brightness  $V_{DIM} : 0\text{V}$ , Min Brightness  $V_{DIM} : 2.2\text{V}$  ( $\approx 0\text{ Nit}$ )

### Mode 3:

| Pin No. | Symbol   | Description                          | Remark    |
|---------|----------|--------------------------------------|-----------|
| 1       | $V_{BL}$ | Power Supply for LED Driver          |           |
| 2       | $V_{BL}$ | Power Supply for LED Driver          |           |
| 3       | EN       | PWM Control Pulse Input              | Note 1, 2 |
| 4       | DIM      | Connect this pin to GND at this mode | Note 3    |
| 5       | GND      | Ground Pin for LED Driver            |           |
| 6       | GND      | Ground Pin for LED Driver            |           |

Note 1: Valley of PWM Pulse  $V_{PWM} < 0.6\text{ V}$ , Peak of PWM Pulse  $V_{PWM} > 1.8\text{ V}$

Note 2: The frequency of each completed PWM cycle: 100~300 Hz

Note 3: The "DIM" pin should be connected to GND in order to get the full brightness.

### 5.3.4 Color Data Reference

The below table is about input signal, Basic display colors and gray scale of each color.

0 : Low Level Voltage      1 : High Level Voltage

Each basic color can be displayed in 64 gray scales from 6 bit data signals. With the combination of total 18 bit data signals, the 262,144 color display can be achieved on the screen.

- Please refer to the next page



|                     | Colors & Gray Scale | Data Signal |    |    |    |    |    |    |    |    |    |    |    |    |    |    |    |    |    |    |
|---------------------|---------------------|-------------|----|----|----|----|----|----|----|----|----|----|----|----|----|----|----|----|----|----|
|                     |                     | Gray Scale  | R0 | R1 | R2 | R3 | R4 | R5 | G0 | G1 | G2 | G3 | G4 | G5 | B0 | B1 | B2 | B3 | B4 | B5 |
| Basic Color         | Black               | -           | 0  | 0  | 0  | 0  | 0  | 0  | 0  | 0  | 0  | 0  | 0  | 0  | 0  | 0  | 0  | 0  | 0  | 0  |
|                     | Blue                | -           | 0  | 0  | 0  | 0  | 0  | 0  | 0  | 0  | 0  | 0  | 0  | 0  | 1  | 1  | 1  | 1  | 1  | 1  |
|                     | Green               | -           | 0  | 0  | 0  | 0  | 0  | 0  | 1  | 1  | 1  | 1  | 1  | 1  | 0  | 0  | 0  | 0  | 0  | 0  |
|                     | Cyan                | -           | 0  | 0  | 0  | 0  | 0  | 0  | 1  | 1  | 1  | 1  | 1  | 1  | 1  | 1  | 1  | 1  | 1  | 1  |
|                     | Red                 | -           | 1  | 1  | 1  | 1  | 1  | 1  | 0  | 0  | 0  | 0  | 0  | 0  | 0  | 0  | 0  | 0  | 0  | 0  |
|                     | Magenta             | -           | 1  | 1  | 1  | 1  | 1  | 1  | 0  | 0  | 0  | 0  | 0  | 0  | 1  | 1  | 1  | 1  | 1  | 1  |
|                     | Yellow              | -           | 1  | 1  | 1  | 1  | 1  | 1  | 1  | 1  | 1  | 1  | 1  | 1  | 0  | 0  | 0  | 0  | 0  | 0  |
|                     | White               | -           | 1  | 1  | 1  | 1  | 1  | 1  | 1  | 1  | 1  | 1  | 1  | 1  | 1  | 1  | 1  | 1  | 1  | 1  |
| Gray Scale of Red   | Black               | GS0         | 0  | 0  | 0  | 0  | 0  | 0  | 0  | 0  | 0  | 0  | 0  | 0  | 0  | 0  | 0  | 0  | 0  | 0  |
|                     | ↑                   | GS1         | 1  | 0  | 0  | 0  | 0  | 0  | 0  | 0  | 0  | 0  | 0  | 0  | 0  | 0  | 0  | 0  | 0  | 0  |
|                     | Darker              | GS2         | 0  | 1  | 0  | 0  | 0  | 0  | 0  | 0  | 0  | 0  | 0  | 0  | 0  | 0  | 0  | 0  | 0  | 0  |
|                     | ↑                   | ↓           |    |    |    | ↓  |    |    |    |    | ↓  |    |    |    |    |    | ↓  |    |    |    |
|                     | ↓                   | ↓           |    |    |    |    |    |    |    |    | ↓  |    |    |    |    |    | ↓  |    |    |    |
|                     | Brighter            | GS61        | 1  | 0  | 1  | 1  | 1  | 1  | 0  | 0  | 0  | 0  | 0  | 0  | 0  | 0  | 0  | 0  | 0  | 0  |
|                     | ↓                   | GS62        | 0  | 1  | 1  | 1  | 1  | 1  | 0  | 0  | 0  | 0  | 0  | 0  | 0  | 0  | 0  | 0  | 0  | 0  |
|                     | Red                 | GS63        | 1  | 1  | 1  | 1  | 1  | 1  | 0  | 0  | 0  | 0  | 0  | 0  | 0  | 0  | 0  | 0  | 0  | 0  |
| Gray Scale of Green | Black               | GS0         | 0  | 0  | 0  | 0  | 0  | 0  | 0  | 0  | 0  | 0  | 0  | 0  | 0  | 0  | 0  | 0  | 0  | 0  |
|                     | ↑                   | GS1         | 0  | 0  | 0  | 0  | 0  | 0  | 1  | 0  | 0  | 0  | 0  | 0  | 0  | 0  | 0  | 0  | 0  | 0  |
|                     | Darker              | GS2         | 0  | 0  | 0  | 0  | 0  | 0  | 0  | 1  | 0  | 0  | 0  | 0  | 0  | 0  | 0  | 0  | 0  | 0  |
|                     | ↑                   | ↓           |    |    |    | ↓  |    |    |    |    |    |    |    |    |    |    |    |    |    |    |
|                     | ↓                   | ↓           |    |    |    | ↓  |    |    |    |    |    |    |    |    |    |    |    |    |    |    |
|                     | Brighter            | GS61        | 0  | 0  | 0  | 0  | 0  | 0  | 1  | 0  | 1  | 1  | 1  | 1  | 0  | 0  | 0  | 0  | 0  | 0  |
|                     | ↓                   | GS62        | 0  | 0  | 0  | 0  | 0  | 0  | 0  | 1  | 1  | 1  | 1  | 1  | 0  | 0  | 0  | 0  | 0  | 0  |
|                     | Green               | GS63        | 0  | 0  | 0  | 0  | 0  | 0  | 1  | 1  | 1  | 1  | 1  | 1  | 0  | 0  | 0  | 0  | 0  | 0  |
| Gray Scale of Blue  | Black               | GS0         | 0  | 0  | 0  | 0  | 0  | 0  | 0  | 0  | 0  | 0  | 0  | 0  | 0  | 0  | 0  | 0  | 0  | 0  |
|                     | ↑                   | GS1         | 0  | 0  | 0  | 0  | 0  | 0  | 0  | 0  | 0  | 0  | 0  | 0  | 1  | 0  | 0  | 0  | 0  | 0  |
|                     | Darker              | GS2         | 0  | 0  | 0  | 0  | 0  | 0  | 0  | 0  | 0  | 0  | 0  | 0  | 0  | 1  | 0  | 0  | 0  | 0  |
|                     | ↑                   | ↓           |    |    |    |    |    |    |    |    |    |    |    |    |    |    |    |    |    |    |
|                     | ↓                   | ↓           |    |    |    |    |    |    |    |    |    |    |    |    |    |    |    |    |    |    |
|                     | Brighter            | GS61        | 0  | 0  | 0  | 0  | 0  | 0  | 0  | 0  | 0  | 0  | 0  | 0  | 1  | 0  | 1  | 1  | 1  | 1  |
|                     | ↓                   | GS62        | 0  | 0  | 0  | 0  | 0  | 0  | 0  | 0  | 0  | 0  | 0  | 0  | 0  | 1  | 1  | 1  | 1  | 1  |
|                     | Blue                | GS63        | 0  | 0  | 0  | 0  | 0  | 0  | 0  | 0  | 0  | 0  | 0  | 0  | 1  | 1  | 1  | 1  | 1  | 1  |

# 5.4 Input Timing Chart

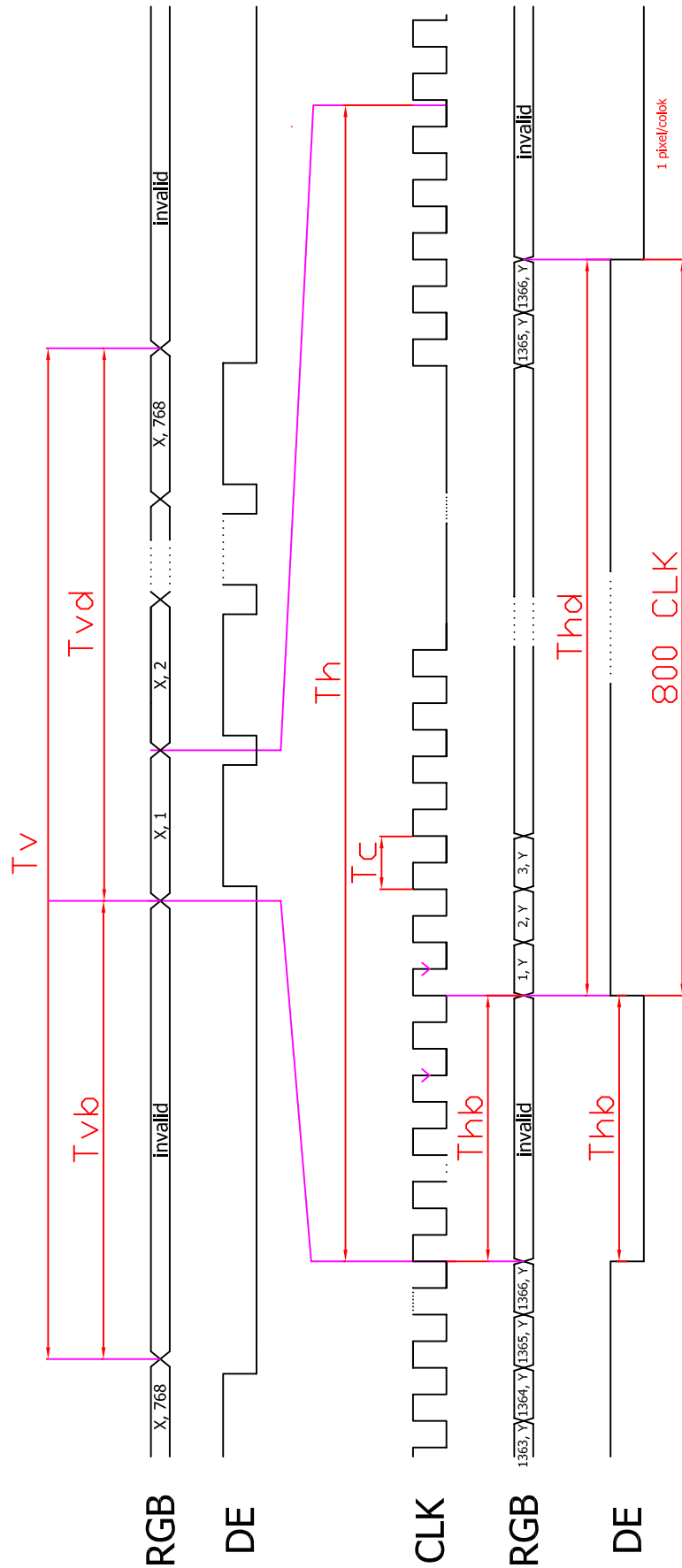



## 6.0 Pixel Format Image

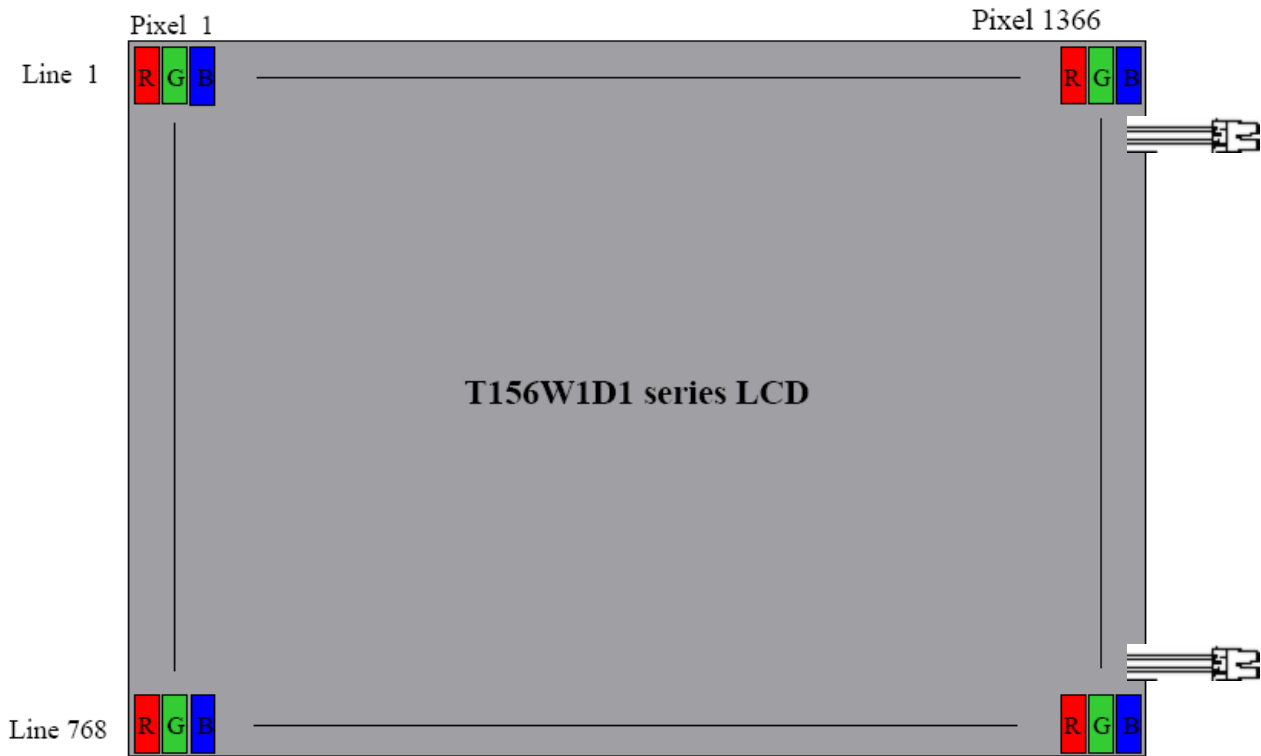

## 7.0 Display Outline Dimensions

### 7.1 Monitor Outline Dimensions

- Please refer to the next page

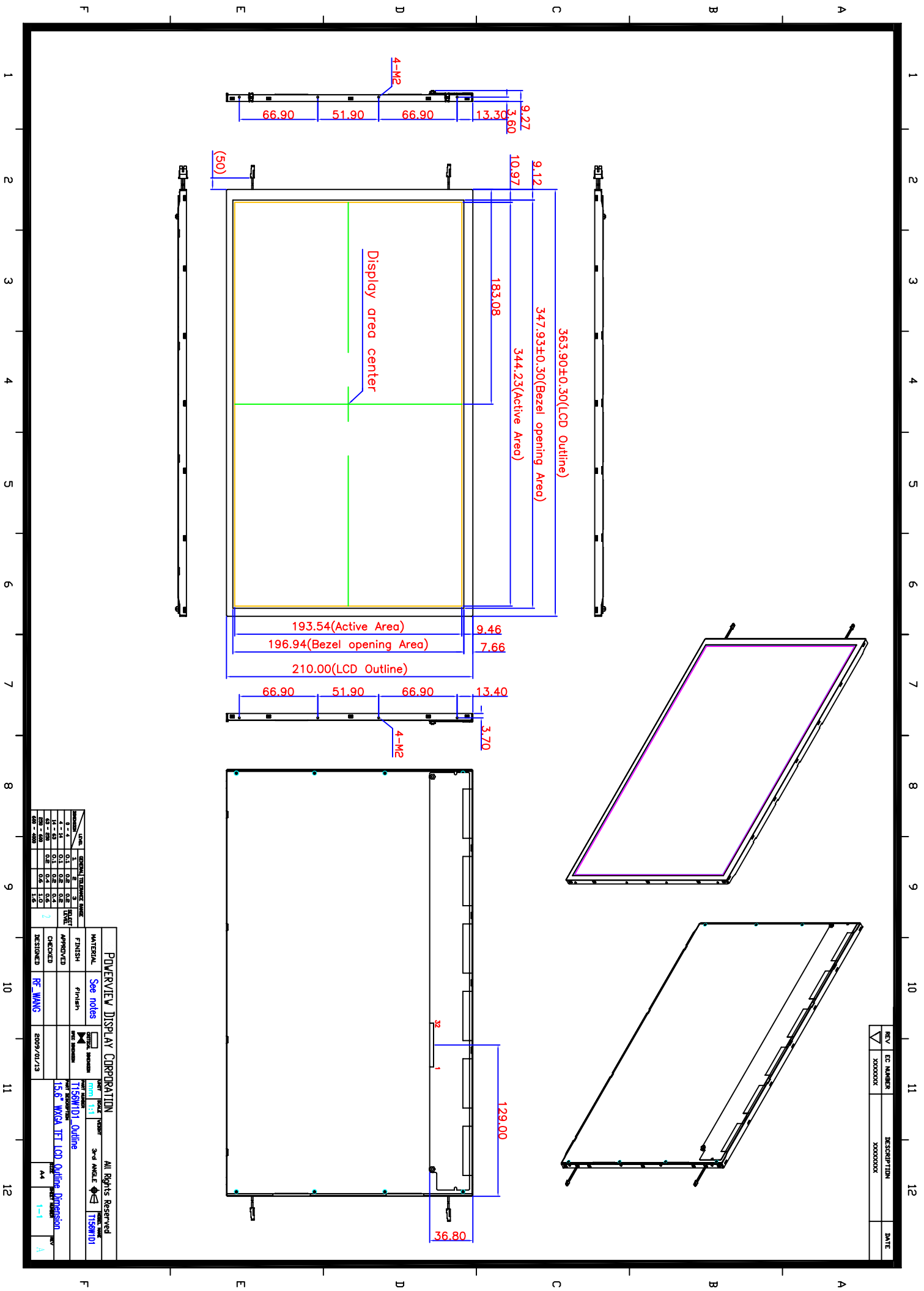

| REV | EC NUMBER | DESCRIPTION | DATE |
|-----|-----------|-------------|------|
| 1   | X00000X   | X00000X     |      |

| UNIT | GENERAL TOLERANCE RANGE | FINISH |
|------|-------------------------|--------|
| mm   | ±0.1                    | 0.1    |
| mm   | ±0.2                    | 0.2    |
| mm   | ±0.3                    | 0.3    |
| mm   | ±0.4                    | 0.4    |
| mm   | ±0.5                    | 0.5    |
| mm   | ±0.6                    | 0.6    |
| mm   | ±0.7                    | 0.7    |
| mm   | ±0.8                    | 0.8    |
| mm   | ±0.9                    | 0.9    |
| mm   | ±1.0                    | 1.0    |
| mm   | ±1.5                    | 1.5    |

|                                     |           |                     |            |
|-------------------------------------|-----------|---------------------|------------|
| POVERVIEW DISPLAY CORPORATION       |           | All Rights Reserved |            |
| MATERIAL                            | See notes | FINISH              | Finish     |
| APPROVED                            |           | CHECKED             |            |
| DESIGNED                            | RE-MANG   | DATE                | 2009/07/13 |
| DRAWN                               |           | DATE                |            |
| T156W1D1 Outline                    |           | T156W1D1            |            |
| 15.6" WGA TFT LCD Outline Dimension |           | A4                  |            |
|                                     |           | 1-1                 |            |
|                                     |           | A                   |            |





## 8.0 Labeling, Packaging & Others

### \* Labeling

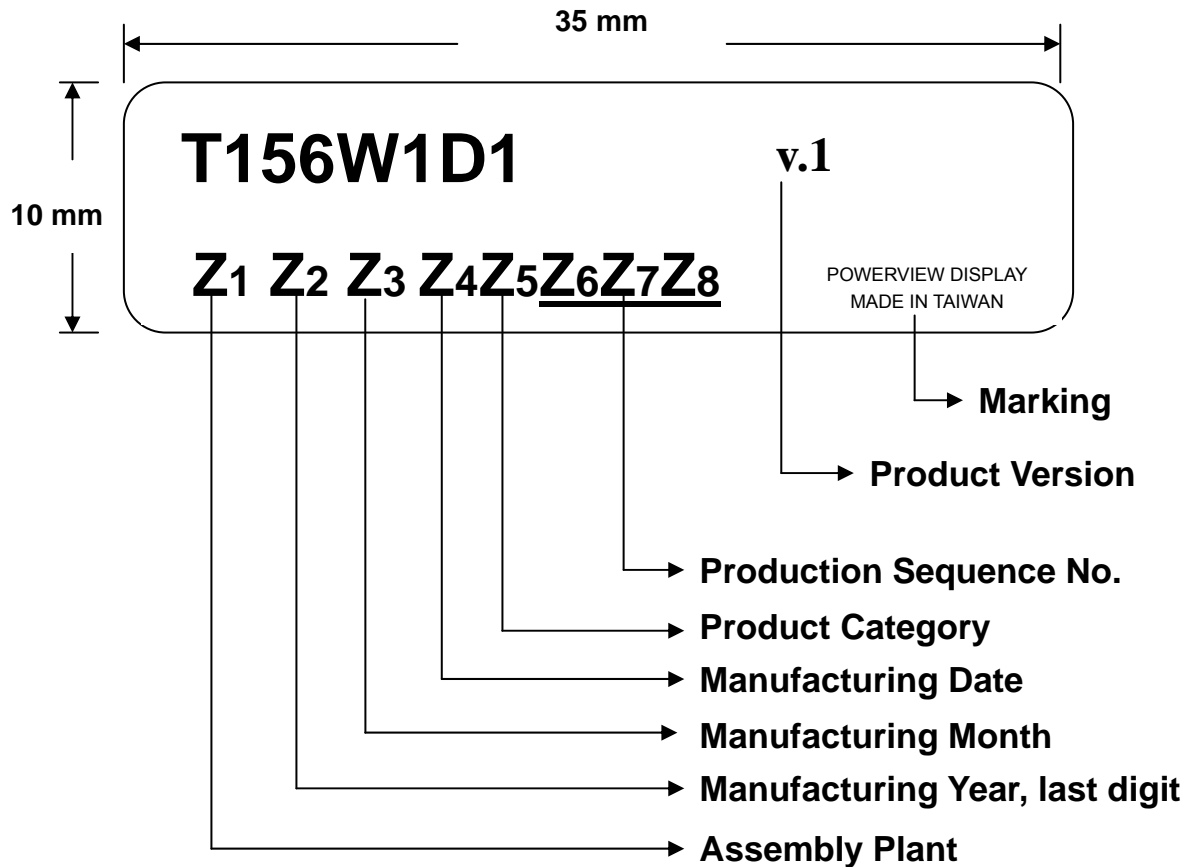

### \* Packaging

- TBD



POWERVIEW DISPLAY CORP.  
銳視光電股份有限公司

To be updated



## 9.0 General Notice

### 9.1 Reliability Test Items (Note 2)

| No. | Test Items                         | Conditions  | Remark                            |
|-----|------------------------------------|---|-----------------------------------|
| 1   | High Temperature Storage           | Ta= + 70°C                      240 Hrs   |                                   |
| 2   | Low Temperature Storage            | Ta= - 30°C                      240 Hrs   |                                   |
| 3   | High Temperature Operation         | Ta= + 60°C                      240 Hrs   |                                   |
| 4   | Low Temperature Operation          | Ta= - 20°C                      240 Hrs   |                                   |
| 5   | High Temperature and High Humidity | Tp= 45°C, 90%RH              240 Hrs  | operation                         |
| 6   | Heat Shock                         | -30~70°C/200 cycles 1Hr/cycle   | Non-operation                     |
| 7   | Electrostatic discharge            | ±200V, 200pF(0Ω), once for each terminal  | Non-operation                     |
| 8   | Vibration                          | Frequency range : 8~33.3 Hz<br>Stoke                      : 1.3mm<br>Sweep                      : 2.9G, 33.3~400Hz<br>Cycle                      : 15 minutes<br>2 hours for each direction of X,Z<br>4 hours for Y direction | JIS C7021,<br>A-10<br>Condition A |
| 9   | Mechanical Shock                   | 100G, 6ms, ±X±Y±Z<br>3 times for each direction   | JIS C7021,<br>A-7<br>Condition C  |
| 10  | Vibration (with carton)            | Random vibration :<br>0.015G <sup>2</sup> /Hz from 5~200Hz<br>-6dB/octave from 200~500Hz  | IEC 68-34                         |
| 11  | Drop (with carton)                 | Height : 60 cm<br>1 corner, 3 edges, 6 surfaces   | JIS Z0202                         |

Note1: Ta: Ambient temperature.

Note 2: In the standard conditions, there is not display function NG issue occurred. All the cosmetic specification is judged before the reliability stress.



## 9.2 Storage, Operation & Others

- (a) Do not leave the panel in high temperature, and high humidity for a long time.  
It is highly recommended to store the module with temperature from 0 to 35°C and relative humidity of less than 70%.
- (b) Do not store the TFT-LCD module in direct sunlight.
- (c) The module shall be stored in a dark place. It is prohibited to apply sunlight or fluorescent light during the store.
- (d) Do not connect, disconnect the module in the "Power On" condition.
- (e) Power supply should always be turned on/off by the item 3.2 "Electrical Absolute Ratings"
- (f) The liquid-crystal is deteriorated by ultraviolet rays. Do not leave it in direct sunlight and strong ultraviolet rays for many hours.
- (g) Avoid condensation of water. It may result in improper operation or disconnection of electrode.
- (h) Do not exceed the absolute maximum rating value. (the supply voltage variation, input voltage variation, variation in part contents and environmental temperature, and so on)  
Otherwise the panel may be damaged.
- (i) If the panel displays the same pattern continuously for a long period of time, it can be the situation when the image "Sticks" to the screen.
- (j) This panel has its circuitry FPC on the bottom side and should be handled carefully in order not to be stressed.