



TFT-LCD MONITOR

Product Specification

MODEL NO. : T121X1D2

Date : 2009.03.27 version 1.1

Prepared by : Jackey Chen

Jackey Chen, Senior Engineer, Product Development Div.

Approved by : Kelvin Hsieh

Kelvin Hsieh, Senior Engineer, Product Development Div.

This TFT LCD Monitor is distributed by:



Display Solution AG
Talhofstraße 32a
D-82205 Gilching
GERMANY
Fon +49 (0)8105 / 73 403 - 0
Fax +49 (0)8105 / 73 403 - 79
E-Mail: info@display-solution.com
Internet: www.display-solution.com

This product specification is subject to change without any notice.



Records of Revision

Date	Rev. No.	Summary	Page
2008.02.26	1.0	First MP Release	
2009.03.27	1.1	4.0 Horizontal Frequency revised to f_H 48.36KHz	8
		5.3.1 JAE-FI-SEB20P-HFE pin pitch revised to 1.25mm	11



Contents	Page
1.0 Handling Precautions	4
2.0 General Description	5
2.1 General Application	5
2.2 Main Features	5
2.3 General Information	5
2.3.1 Display Characteristics	5
2.3.2 Mechanical Dimensions	6
3.0 Absolute Maximum Ratings	6
3.1 Absolute Ratings of Environment Requirement	6
3.2 Electrical Absolute Ratings	7
3.2.1 TFT-LCD Module	7
3.2.2 Backlight Module(LED)	7
4.0 Optical Characteristics	8
5.0 Electrical Characteristics	10
5.1 AC Timing Characteristics	10
5.2 DC Characteristics	10
5.2.1 TFT-LCD Module	10
5.2.2 Backlight Unit & LED Driver	11
5.3 Input Terminal Pin Assignment	11
5.3.1 Signal Input Interface	11
5.3.2 LED Driver Unit	12
5.3.3 Scanning Direction	12
5.3.4 Color Data Reference	13
5.4 Input Timing Chart	15
6.0 Pixel Format Image	16
7.0 Display Outline Dimensions	16
8.0 Labeling, Packaging & Others	19
9.0 General Notices	21
9.1 Reliability Test Item	21
9.2 Storage, Operation & Others	22



1.0 Handling Precaution

- 1.) Handle with care. Pay attention not to press or scratch the surface of the monitor, especially the polarizer. Do not twist or bend the monitor. It may cause un-recoverable damage.
- 2.) Do not drop or bump the monitor since this monitor contains fragile glass components. Breakage of this monitor might cause leakage of the liquid crystal sealed inside the glasses. Do not touch the liquid crystal liquid in case of leakage. **Flush with massive water immediately in case of contact with your skin by liquid crystal fluid and call for doctor for immediate medical treatment.**
- 3.) Be sure to turn off power supply while plug or un-plug the power input connector.
- 4.) Clean up the polarizer only with soft solvent if necessary. The desirable cleaners are water, IPA(Isopropyl Alcohol) or Hexane. Do not use Ketone type materials (ex. Acetone), Ethyl alcohol, toluene, Ethyl acid or Methyl chloride. It will permanently damage the polarizer due to chemical reaction. 5.) Wipe off fluid drop immediately to prevent from possible discoloration or spots on the polarizer.
- 6.) Do not twist nor bend the monitor structure, even momentarily. Bending or twisting torque may likely damage the internal components of the monitor.
- 7.) The cold cathode fluorescent lamp in LCD contains small amount of mercury (Hg). Please refer to the design specification for application and the local regulations and environmental laws for disposal purpose.
- 8.) Protect the monitor from static environment to prevent from damage to the CMOS gate array IC.



2.0 General Description

T121X1D2 is a 12.1 inch (4:3 aspect ratio) color active matrix TFT LCD monitor with excellent display performance driven by a pure **DIGITAL** LVDS interface assembled in a compact and slim **LED backlight** unit. This LCD supports 1024(H) x RGB x 768(V) stripe color pixel format and 262,144 colors (RGB 6 bits data) with vivid color image. Its outstanding performances with wide operation temperature range, **-30 ~ +70°C**, high brightness, **400 nits(typ.)**, super wide viewing angle(160°/160°) and ultra high contrast ratio 700:1, make this monitor very suitable for applications under severe environments or outdoor use.

2.1 General Applications

- Display terminal for applications of Car Navigation, Industrial, Medical, Gaming, HMI, Amusement, Advertisement or more

2.2 Main Features

- 4:3 1024 x RGB x 768 Display Aspect Ratio
- LED Backlight with Extreme Power Saving
- Ultra Wide Viewing Angle
- Ultra High Contrast Ratio
- Ultra Wide Operational Temperature Range
- High Color Saturation
- Fast Response Time
- Pure Digital LVDS (Low Voltage Differential Signaling) Interface
- DE (Data Enable) Mode
- RoHS Compliance

2.3 General Information

2.3.1 Display Characteristics

Item	Specification	Unit	Note
Display Area (HxV)	245.76 x 184.32	mm	12.1" Diagonal
Driver Element	a-Si TFT Active Matrix	-	-
Number of Pixels (HxV)	1024 x RGB x 768	pixel	Std. 4:3
Pixel Arrangement	R.G.B Vertical Stripe	-	-
Dot Pitch (HxV)	0.080 x 0.240	mm	Dot
Viewing Angle (H/V)	160/160	degree	6 o'clock
Signal Interface	LVDS, Digital RGB 18 bits		262K colors
Display Mode	Normally White	-	-
Surface Treatment	3H Hard Coating, 25% Haze AG	-	-



2.3.2 Mechanical Dimensions

Item		Min.	Typ.	Max.	Unit	Note
Dimension	Horizontal	260.0	260.5	261	mm	±0.5 mm
	Vertical	203.5	204.0	204.5		±0.5 mm
	Depth	-	12.2	12.7		+0.5 mm
Weight		-	-	660	g	±10 g

3.0 Absolute Maximum Ratings

3.1 Absolute Ratings of Environment Requirement

Item	Symbol	Min.	Max.	Unit	Note
Storage Temperature	Tstg	-30	+ 80	°C	
Operation Temperature (Ambient Temperature)	Top	-30	+ 70	°C	

Note (1) Temperature and relative humidity range are shown in the figure below.

95% RH Max. ($40^{\circ}\text{C} > T_a$)

Maximum wet – bulb temperature at 39°C or less. ($T_a > 40^{\circ}\text{C}$) No condensation.

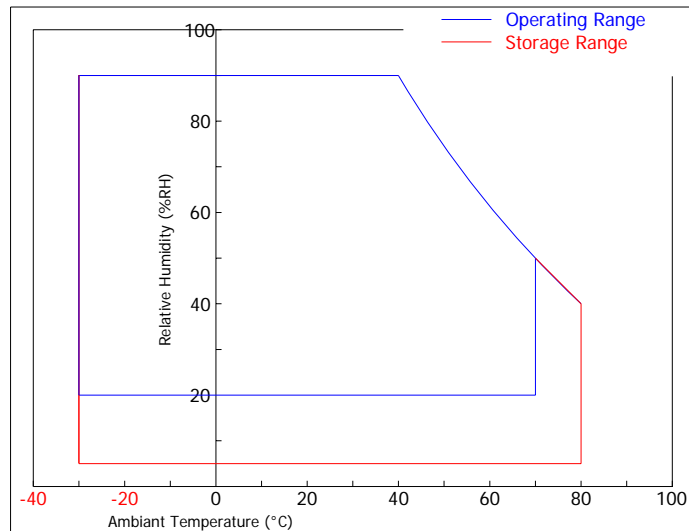



3.2 Electrical Absolute Ratings

3.2.1 TFT-LCD Module

(Ta=25±2°C), Vgg=GND=0V)

Item	SYMBOL	Min.	Max.	UNIT	NOTE
Power Supply Voltage	V _{DD}	-0.3	4.0	V	(1),(2)
Logic Input Voltage	V _{i1}	-0.3	2.7	V	(1),(2)

3.2.2 Backlight Module(LED)

Item	SYMBOL	MIN	MAX	UNIT	NOTE
Input DC Voltage	V _{BL}	-	15	V	(1),(2)

Note (1) Within operating temperature

Note (2) Permanent damage to the device may occur if maximum values are exceeded.

Functional operation should be restricted to the conditions described under normal operating conditions.



4.0 Optical Characteristics

The following items are measured under stable conditions in a dark room or equivalent state.

* Measuring Equipment: BM-5A, PR-650

($V_{DD}=3.3V$, $f_V=60Hz$, $f_H=48.36KHz$, $T_a=25\pm 2^\circ C$)

Item		Symbol	Condition	Min.	Typ.	Max.	Unit	Note
Contrast Ratio		CR	At optimized Viewing Angle	500	700	-	-	(1)(2) (4)
Response Time at 25°C	Rising	T_R	$\theta=0^\circ$	-	6	11	ms	(3)
	Falling	T_F		-	17	22		
Luminance(center)		Y_L	$V_{DIM=max}$		400	-	cd/m ²	(1)(2) (6)
Color Chromaticity (CIE 1931)	White	W_X			TBD		-	(2)(6)
		W_Y			TBD		-	
Viewing Angle	Hor.	θ_L	CR \geq 10 at center point	70	80	-	Degree	(2)(5)
		θ_R		70	80	-		
	Ver.	θ_H		70	80	-		
		θ_V		70	80	-		

Note (1) : Ambient temperature =25°C , and $V_{DIM} = 1.5V_{max}$. To be measured in the dark room.

Note (2) : To be measured on the center area of panel with a viewing cone of 1° by Topcon Luminance Meter BM-5, after 10 minutes operation.

Note (3) : Definition of response time:

The output signals of photo detector are measured when the input signals are changed from “black” to “white”(falling time) and from “white” to “black”(rising time), respectively.

The response time is defined as the time interval between the 10% and 90% of amplitudes. Refer to figure as below.

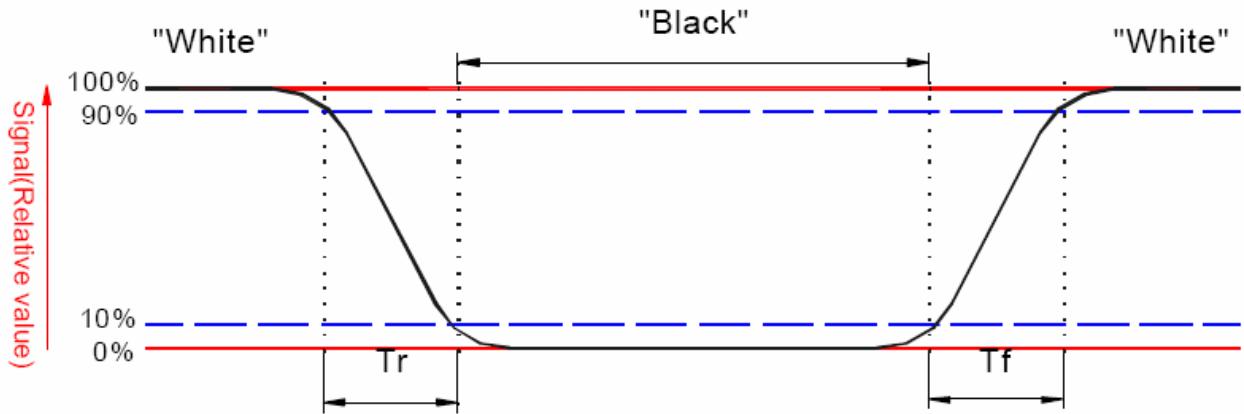

Note (4) : Definition of contrast ratio:

Contrast ratio is calculated with the following formula.

$$\text{Contrast ratio (CR)} = \frac{\text{Photo detector output when LCD is at "White" state}}{\text{Photo detector output when LCD is at "Black" state}}$$

Note (5) : Definition of viewing angle, Refer to figure as below.

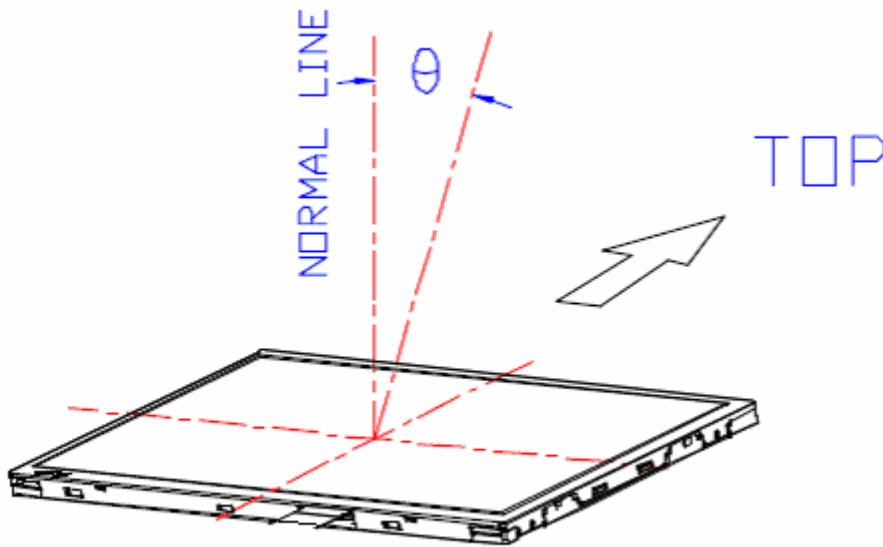

Note (6) : Measured at the center area of the panel when all the input terminals of LCD panel are electrically opened.

5.0 Electrical Characteristics

5.1 AC Timing Characteristics

Signal	Item	Symbol	Min.	Typ.	Max.	Unit	Note
LVDS Clock	Frequency	Fc	57.5	64.9	74.4	MHz	-
	Period	Tc	13.4	15.4	17.3	ns	
Vertical Active Display Term	Frame Rate	Fr	56	60	75	Hz	Tv=Tvd+Tvb
	Total	Tv	774	806	848	Th	-
	Display	Tvd	768	768	768	Th	-
	Blank	Tvb	Tv-Tvd	38	Tv-Tvd	Th	-
Horizontal Active Display Term	Total	Th	1240	1344	1464	Tc	Th=Thd+Thb
	Display	Thd	1024	1024	1024	Tc	-
	Blank	Thb	Th-Thd	320	Th-Thd	Tc	-

Note : (1) Hsync and Vsync input signals should be set to low logic level or ground because this LCD module is operated by "DE only" mode. Otherwise, this module would operate abnormally.

5.2 DC Characteristics

5.2.1 TFT-LCD Module

Item	Symbol	Min.	Typ.	Max.	Unit	Note	
Power Supply	V _{DD}	3.0	3.3	3.6	V	(1)	
	I _{DD}	White	-	400	-	mA	V _{DD} =3.3V
		Black		730	-	mA	
Permissive Input Ripple Voltage	V _{RF}	-	-	100	mV _{P-P}	V _{DD} =3.3V	
LVDS Differential Input Voltage	V _{id}	-100		100	mV		
LVDS Common Input Voltage	V _{ic}		1.2		V		

Note (1) VDD Power-On Condition :

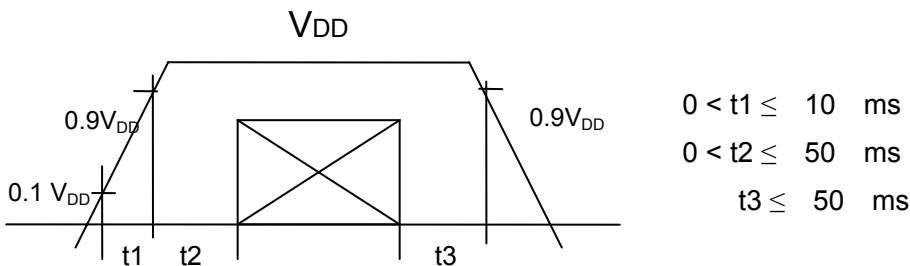

Note (2) CLK, Hsync, Vsync, DE, R0~R5, G0~G5, B0~B5



5.2.2 Backlight Unit & LED Driver

Item	Symbol	Min.	Typ.	Max.	Unit	Note
Power Supply	V_{BL}	10.8	12	13.2	V	
	I_{BL}		0.38		Amp	$V_{BL} = 12V$

Note 1 : $V_{BL} = 12V$, using the Mode 2 of LED control scheme and $V_{DIM} = 0V$ to get the maximum brightness.

5.3 Input Terminal Pin Assignment

5.3.1 Signal Input Interface

JAE Connector: 20 pin 1.25 mm pitch JAE-FI-SEB20P-HFE

CN 1

Mating Connector : JAE JAE-FI-SE20M, FI-S20S or equivalent

Pin No	Symbol	Description	Remark
1	V_{CC_IN}	Power supply (+5V / 3.3V)	-
2	V_{CC_IN}	Power Supply (+5V / 3.3V)	-
3	GND	Ground	-
4	GND	Ground	-
5	RxIN0-	LVDS receiver signal channel 0	R0~R5, G0
6	RxIN0+		
7	GND	Ground	-
8	RxIN1-	LVDS receiver signal channel 1	G1~G5, B0, B1
9	RxIN1+		
10	GND	Ground	-
11	RxIN2-	LVDS receiver signal channel 2	B2~B5, DE, Hsync, Vsync
12	RxIN2+		
13	GND	Ground	-
14	CLKIN-	LVDS receiver signal clock	LVDS Level Colck
15	CLKIN+		
16	GND	Ground	-
17	NC	No connection	-
18	NC	No connection	-
19	GND	Ground	-
20	GND	Ground	-



5.3.2 LED Driver Unit

Connector : ACES 88290-0601 pitch 2.0mm 6 pins CN

Mode 1 :

Matching Connector : ACES 86809-0600 CN

Pin No.	Symbol	Description	Remark
1	V _{BL}	Power Supply for LED Driver	
2	V _{BL}	Power Supply for LED Driver	
3	EN	LED Enable & Dimming Control Input	Note 1
4	DIM	Connect this pin to GND at this mode	Note 2
5	GND	Ground Pin for LED Driver	
6	GND	Ground Pin for LED Driver	

Note 1 : The “Enable & Dimming Control” of the LED driver shares the same pinning.

The LED backlight will turn on when the input voltage of this pin exceeds +0.6V.

The LED current/brightness will be adjustable by applying an analog voltage between +0.8 ~ +1.4V(Max. Brightness).

Note 2: The “DIM” pin should be connected to GND in order to get the full brightness.

Mode 2:

Pin No.	Symbol	Description	Remark
1	V _{BL}	Power Supply for LED Driver	
2	V _{BL}	Power Supply for LED Driver	
3	EN	LED Enable Control Input	Note 1
4	DIM	Dimming Control Input	Note 2
5	GND	Ground Pin for LED Driver	
6	GND	Ground Pin for LED Driver	

Note 1 : Disable V_{EN}<0.6 V, Enable V_{EN}>1.8 V

Note 2 : Max Brightness V_{DIM} : 0V, Min Brightness V_{DIM} : 2.2V (≈ 0 Nit)

Mode 3:

Pin No.	Symbol	Description	Remark
1	V _{BL}	Power Supply for LED Driver	
2	V _{BL}	Power Supply for LED Driver	
3	EN	PWM Control Pulse Input	Note 1, 2
4	DIM	Connect this pin to GND at this mode	Note 3
5	GND	Ground Pin for LED Driver	
6	GND	Ground Pin for LED Driver	

Note 1: Valley of PWM Pulse V_{PWM}<0.6 V, Peak of PWM Pulse V_{PWM} >1.8 V

Note 2: The frequency of each completed PWM cycle: 100~300 Hz

Note 3: The “DIM” pin should be connected to GND in order to get the full brightness.



5.3.4 Color Data Reference

The below table is about input signal, Basic display colors and gray scale of each color.

0 : Low Level Voltage 1 : High Level Voltage

Each basic color can be displayed in 64 gray scales from 6 bit data signals. With the combination of total 18 bit data signals, the 262,144 color display can be achieved on the screen.

- Please refer to the next page



	Colors & Gray Scale	Data Signal																		
		Gray Scale	R0	R1	R2	R3	R4	R5	G0	G1	G2	G3	G4	G5	B0	B1	B2	B3	B4	B5
Basic Color	Black	-	0	0	0	0	0	0	0	0	0	0	0	0	0	0	0	0	0	0
	Blue	-	0	0	0	0	0	0	0	0	0	0	0	0	1	1	1	1	1	1
	Green	-	0	0	0	0	0	0	1	1	1	1	1	1	0	0	0	0	0	0
	Cyan	-	0	0	0	0	0	0	1	1	1	1	1	1	1	1	1	1	1	1
	Red	-	1	1	1	1	1	1	0	0	0	0	0	0	0	0	0	0	0	0
	Magenta	-	1	1	1	1	1	1	0	0	0	0	0	0	1	1	1	1	1	1
	Yellow	-	1	1	1	1	1	1	1	1	1	1	1	1	0	0	0	0	0	0
	White	-	1	1	1	1	1	1	1	1	1	1	1	1	1	1	1	1	1	1
Gray Scale of Red	Black	GS0	0	0	0	0	0	0	0	0	0	0	0	0	0	0	0	0	0	0
	↑	GS1	1	0	0	0	0	0	0	0	0	0	0	0	0	0	0	0	0	0
	Darker	GS2	0	1	0	0	0	0	0	0	0	0	0	0	0	0	0	0	0	0
	↑	↓				↓					↓						↓			
	↓	↓									↓						↓			
	Brighter	GS61	1	0	1	1	1	1	0	0	0	0	0	0	0	0	0	0	0	0
	↓	GS62	0	1	1	1	1	1	0	0	0	0	0	0	0	0	0	0	0	0
	Red	GS63	1	1	1	1	1	1	0	0	0	0	0	0	0	0	0	0	0	0
Gray Scale of Green	Black	GS0	0	0	0	0	0	0	0	0	0	0	0	0	0	0	0	0	0	0
	↑	GS1	0	0	0	0	0	0	1	0	0	0	0	0	0	0	0	0	0	0
	Darker	GS2	0	0	0	0	0	0	0	1	0	0	0	0	0	0	0	0	0	0
	↑	↓				↓														
	↓	↓				↓														
	Brighter	GS61	0	0	0	0	0	0	1	0	1	1	1	1	0	0	0	0	0	0
	↓	GS62	0	0	0	0	0	0	0	1	1	1	1	1	0	0	0	0	0	0
	Green	GS63	0	0	0	0	0	0	1	1	1	1	1	1	0	0	0	0	0	0
Gray Blue	Black	GS0	0	0	0	0	0	0	0	0	0	0	0	0	0	0	0	0	0	0
	↑	GS1	0	0	0	0	0	0	0	0	0	0	0	0	1	0	0	0	0	0
	Darker	GS2	0	0	0	0	0	0	0	0	0	0	0	0	0	1	0	0	0	0
	↑	↓																		
	↓	↓																		
	Brighter	GS61	0	0	0	0	0	0	0	0	0	0	0	0	1	0	1	1	1	1
	↓	GS62	0	0	0	0	0	0	0	0	0	0	0	0	0	1	1	1	1	1
	Blue	GS63	0	0	0	0	0	0	0	0	0	0	0	0	1	1	1	1	1	1



6.0 Pixel Format Image

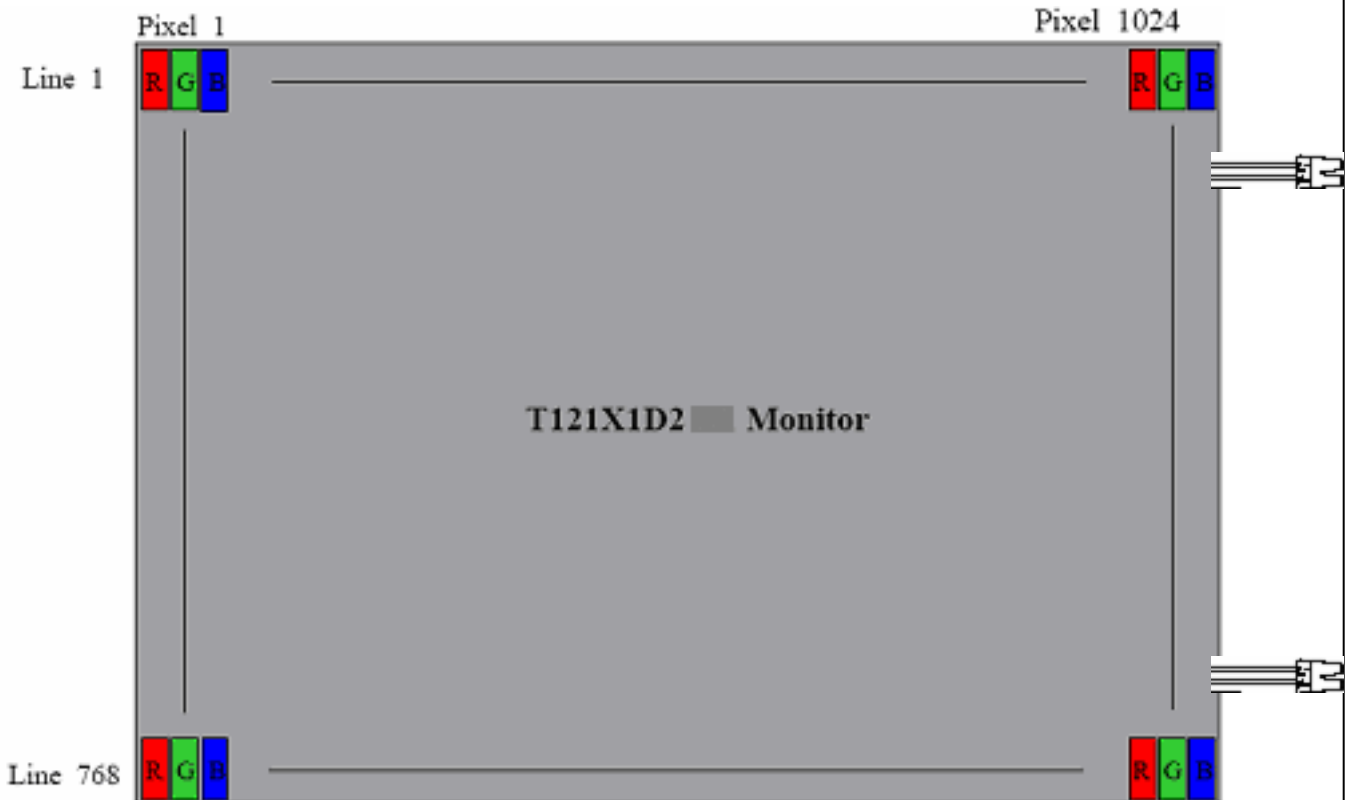

7.0 Display Outline Dimensions

7.1 Monitor Outline Dimensions

- Please refer to the next page

REV	EQ NUMBER	DESCRIPTION	DATE
△	XXXXXX	XXXXXX	

NOTE:
 1. OUTLINE TOLERANCE: ±0.5mm.
 2. MAX SCREW LENGTH: 2.7mm
 3. MAX SCREW TORQUE: 2.0 kg-cm.

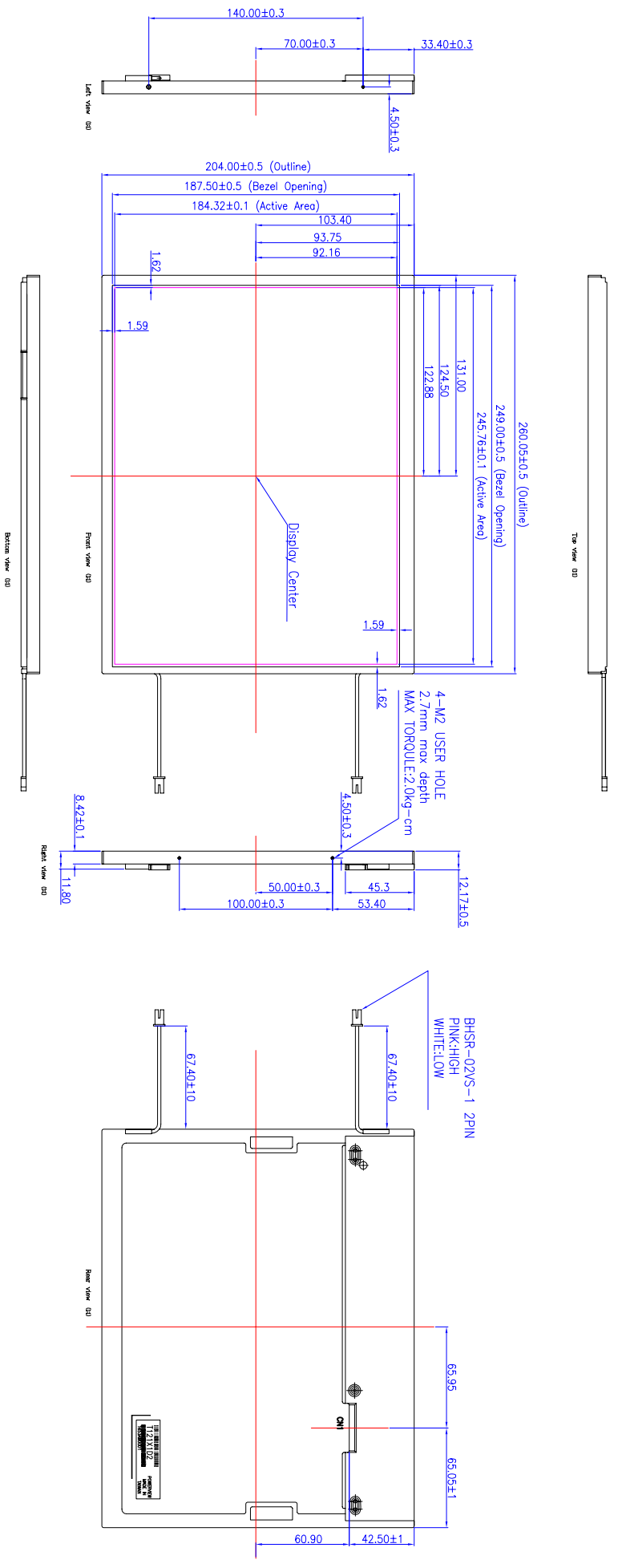

Dimension	Min	Max	Material	Notes
0.1 - 1	0.1	0.2	0.2	0.2
1 - 3	0.1	0.2	0.2	0.2
3 - 6	0.1	0.2	0.2	0.2
6 - 12	0.1	0.2	0.2	0.2
12 - 20	0.1	0.2	0.2	0.2
20 - 30	0.1	0.2	0.2	0.2
30 - 50	0.1	0.2	0.2	0.2
50 - 100	0.1	0.2	0.2	0.2
100 - 200	0.1	0.2	0.2	0.2
200 - 500	0.1	0.2	0.2	0.2
500 - 1000	0.1	0.2	0.2	0.2

POVERTVIEW DISPLAY CORPORATION				All Rights Reserved			
MATERIAL	FINISH	APPROVED	CHECKED	DESIGNED	DATE	REV	DATE
See notes	Finish				2008/09/08	1-1	A
Part Number	Part Name	3rd ANGLE	Scale	Material	Rev	Rev	Rev
1121X102	1121X102	3rd ANGLE	1:1	1121X102	1-1	1-1	1-1
1121X102	1121X102	3rd ANGLE	1:1	1121X102	1-1	1-1	1-1
1121X102	1121X102	3rd ANGLE	1:1	1121X102	1-1	1-1	1-1

REV	EC NUMBER	DESCRIPTION	DATE
1	XXXXXX	XXXXXX	

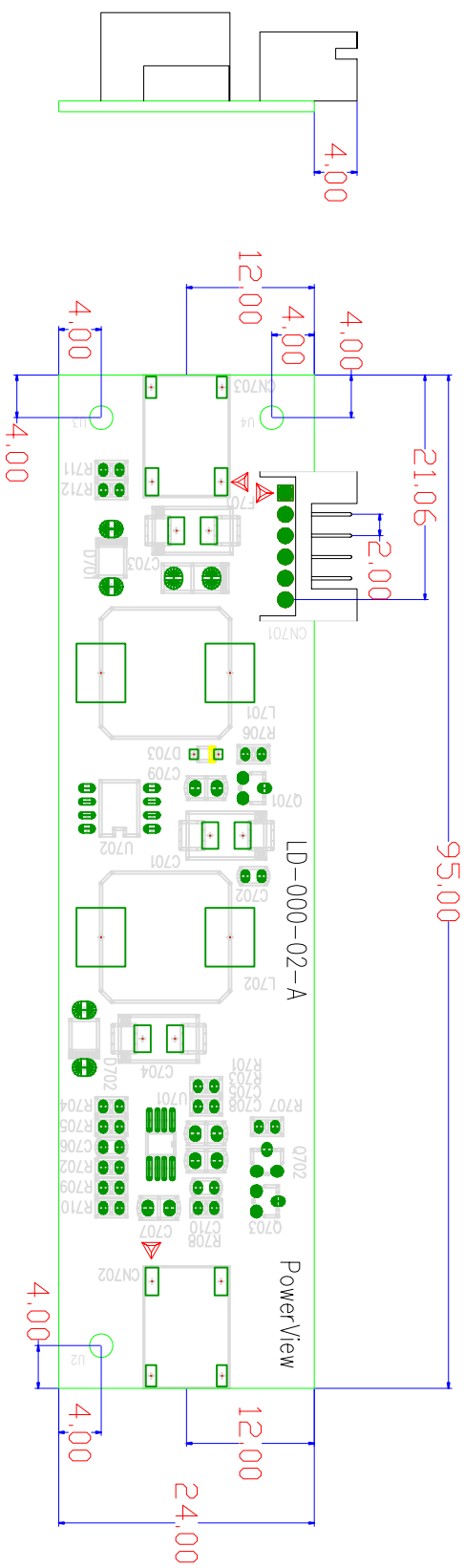

CN701	
SYMBOL	DESCRIPTION
Pin 1	Vin
Pin 2	Vin
Pin 3	ENA
Pin 4	DIM
Pin 5	GND
Pin 6	GND

CN702 / CN703	
SYMBOL	DESCRIPTION
Pin 1	Anode
Pin 2	Cathod

CN702 / CN703	
SYMBOL	DESCRIPTION
Pin 1	Anode DC Power Supply for Backlight Unit
Pin 2	Cathod DC Power Supply for Backlight Unit

SIZE	GENERAL TOLERANCE	FINISH
0.1	0.1	0.1
0.2	0.2	0.2
0.3	0.3	0.3
0.4	0.4	0.4
0.5	0.5	0.5
0.6	0.6	0.6
0.7	0.7	0.7
0.8	0.8	0.8
0.9	0.9	0.9
1.0	1.0	1.0
1.1	1.1	1.1
1.2	1.2	1.2
1.3	1.3	1.3
1.4	1.4	1.4
1.5	1.5	1.5
1.6	1.6	1.6

POWERVIEW DISPLAY CORPORATION		All Rights Reserved	
MATERIAL	See Index	DATE	3rd ANGLE
FINISH	Finish	DATE	3rd ANGLE
APPROVED	APPROVED	DATE	3rd ANGLE
CHECKED	CHECKED	DATE	3rd ANGLE
DESIGNED	DESIGNED	DATE	3rd ANGLE
	Tim	2007/1/12	
		080236210120-00	43
			1-1
			A



8.0 Labeling, Packaging & Others

* Labeling

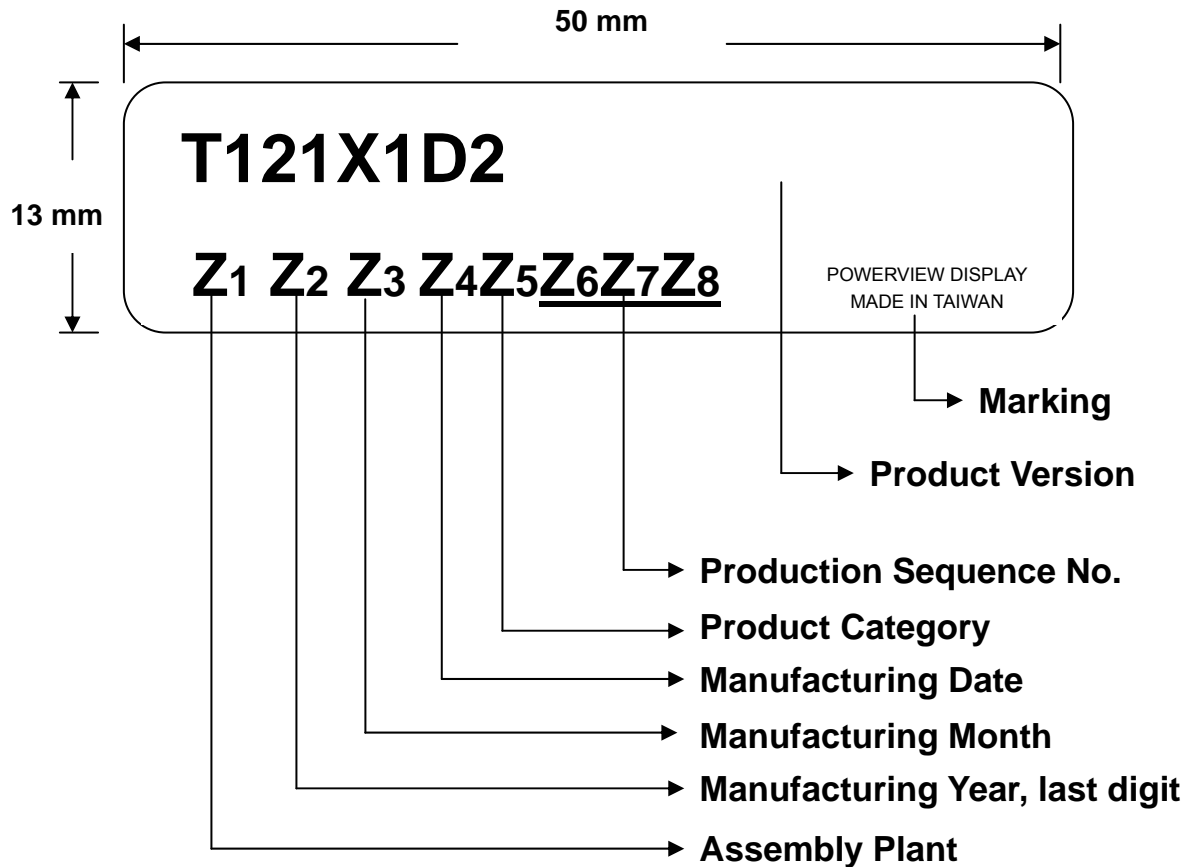

* Packaging

- TBD





9.0 General Notice

9.1 Reliability Test Items (Note 2)

No.	Test Items	Conditions	Remark
1	High Temperature Storage	Ta= + 80°C 240 Hrs	
2	Low Temperature Storage	Ta= - 30°C 240 Hrs	
3	High Temperature Operation	Ta= + 70°C 240 Hrs	
4	Low Temperature Operation	Ta= - 30°C 240 Hrs	
5	High Temperature and High Humidity	Tp= 60°C, 90%RH 240 Hrs	operation
6	Heat Shock	-25~80°C/200 cycles 1Hr/cycle	Non-operation
7	Electrostatic discharge	±200V, 200pF(0Ω), once for each terminal	Non-operation
8	Vibration	Frequency range : 8~33.3 Hz Stoke : 1.3mm Sweep : 2.9G, 33.3~400Hz Cycle : 15 minutes 2 hours for each direction of X,Z 4 hours for Y direction	JIS C7021, A-10 Condition A
9	Mechanical Shock	100G, 6ms, ±X±Y±Z 3 times for each direction	JIS C7021, A-7 Condition C
10	Vibration (with carton)	Random vibration : 0.015G ² /Hz from 5~200Hz -6dB/octave from 200~500Hz	IEC 68-34
11	Drop (with carton)	Height : 60 cm 1 corner, 3 edges, 6 surfaces	JIS Z0202

Note1: Ta: Ambient temperature.

Note 2: In the standard conditions, there is not display function NG issue occurred. All the cosmetic specification is judged before the reliability stress.



9.2 Storage, Operation & Others

- (a) Do not leave the panel in high temperature, and high humidity for a long time.
It is highly recommended to store the module with temperature from 0 to 35°C and relative humidity of less than 70%.
- (b) Do not store the TFT-LCD module in direct sunlight.
- (c) The module shall be stored in a dark place. It is prohibited to apply sunlight or fluorescent light during the store.
- (d) Do not connect, disconnect the module in the "Power On" condition.
- (e) Power supply should always be turned on/off by the item 3.2 "Electrical Absolute Ratings"
- (f) The liquid-crystal is deteriorated by ultraviolet rays. Do not leave it in direct sunlight and strong ultraviolet rays for many hours.
- (g) Avoid condensation of water. It may result in improper operation or disconnection of electrode.
- (h) Do not exceed the absolute maximum rating value. (the supply voltage variation, input voltage variation, variation in part contents and environmental temperature, and so on) Otherwise the panel may be damaged.
- (i) If the panel displays the same pattern continuously for a long period of time, it can be the situation when the image "Sticks" to the screen.
- (j) This panel has its circuitry FPC on the bottom side and should be handled carefully in order not to be stressed.