



TFT-LCD MONITOR

Product Information

Temporary

MODEL NO. : T104X1D3

Date : 2008.07.29 Revision 0.2

Prepared by : _____

Nicholas Shieh, Engineer, Product Development Div.

Approved by : _____

Jackey Chien, Director, Product Development Div.

This TFT LCD Monitor is distributed by:



Display Solution AG
Talhofstraße 32a
D-82205 Gilching
GERMANY
Fon +49 (0)8105 / 73 403 - 0
Fax +49 (0)8105 / 73 403 - 79
E-Mail: info@display-solution.com
Internet: www.display-solution.com

This product specification is subject to change without any notice.



Records of Revision

Date	Rev. No.	Summary	Page
2008/02/19	0.1	First Temporary Release	1
2008/7/29 (temp.)	0.2	2.3.2 Dimension/depth revised to 8.3mm	6
		5.3.2 Pin assignment revised	12
		5.4 Timing Chart Revised	15



Contents	Page
1.0 Handling Precautions	4
2.0 General Description	5
2.1 General Application	5
2.2 Main Features	5
2.3 General Information	5
2.3.1 Display Characteristics	5
2.3.2 Mechanical Dimensions	6
3.0 Absolute Maximum Ratings	6
3.1 Absolute Ratings of Environment Requirement	6
3.2 Electrical Absolute Ratings	6
3.2.1 TFT-LCD Module	7
3.2.2 Backlight Module(LED)	7
4.0 Optical Characteristics	8
5.0 Electrical Characteristics	10
5.1 AC Timing Characteristics	10
5.2 DC Characteristics	10
5.2.1 TFT-LCD Module	10
5.2.2 Backlight Unit & LED Driver	11
5.3 Input Terminal Pin Assignment	11
5.3.1 Signal Input Interface	11
5.3.2 LED Driver Unit	12
5.3.3 Scanning Direction	12
5.3.4 Color Data Reference	13
5.4 Input Timing Chart	15
6.0 Pixel Format Image	16
7.0 Display Outline Dimensions	16
8.0 Labeling, Packaging & Others	19
9.0 General Notices	21
9.1 Reliability Test Item	21
9.2 Storage, Operation & Others	22



1.0 Handling Precaution

- 1.) Handle with care. Pay attention not to press or scratch the surface of the monitor, especially the polarizer. Do not twist or bend the monitor. It may cause un-recoverable damage.
- 2.) Do not drop or bump the monitor since this monitor contains fragile glass components. Breakage of this monitor might cause leakage of the liquid crystal sealed inside the glasses. Do not touch the liquid crystal liquid in case of leakage. **Flush with massive water immediately in case of contact with your skin by liquid crystal fluid and call for doctor for immediate medical treatment.**
- 3.) Be sure to turn off power supply while plug or un-plug the power input connector.
- 4.) Clean up the polarizer only with soft solvent if necessary. The desirable cleaners are water, IPA(Isopropyl Alcohol) or Hexane. Do not use Ketone type materials (ex. Acetone), Ethyl alcohol, toluene, Ethyl acid or Methyl chloride. It will permanently damage the polarizer due to chemical reaction. 5.) Wipe off fluid drop immediately to prevent from possible discoloration or spots on the polarizer.
- 6.) Do not twist nor bend the monitor structure, even momentarily. Bending or twisting torque may likely damage the internal components of the monitor.
- 7.) The cold cathode fluorescent lamp in LCD contains small amount of mercury (Hg). Please refer to the design specification for application and the local regulations and environmental laws for disposal purpose.
- 8.) Protect the monitor from static environment to prevent from damage to the CMOS gate array IC.



2.0 General Description

T104X1D3 is a 10.4 inch (4:3 aspect ratio) color active matrix TFT LCD monitor with excellent display performance driven by a LVDS interface assembled in a compact and slim LED backlight unit. This LCD supports 1024(H) x RGB x 768(V) stripe color pixel format and 16.7 million colors (RGB 8 bits data) with vivid color image. Its outstanding performances with wide operation temperature range, **-20 ~ 70°C**, good brightness, **300 nits(typ.) with LED Backlight**, ultra wide viewing angle(176°/176°) and ultra high contrast ratio 1200:1, make this monitor very suitable for applications under severe environments or outdoor use.

2.1 General Applications

- Display terminal for applications of Car Navigation, Industrial, Medical, Gaming, Amusement, Advertisement and more

2.2 Main Features

- 10.4" 1024xRGBx768 Resolution with 4:3 Display Aspect Ratio
- LED Backlight
- Slim Bezel Mechanical Design
- Ultra Wide Viewing Angle
- Ultra High Contrast Ratio
- Wide Temperature Range
- High Color Saturation
- 24 bits LVDS Interface with 16.7 Million Colors
- Image Rotation Options
- RoHS Compliance

2.3 General Information

2.3.1 Display Characteristics

Item	Specification	Unit	Note
Display Area (HxV)	210.43 x 157.82 (10.4" Diagonal)	mm	-
Driver Element	a-Si TFT Active Matrix	-	-
Number of Pixels (HxV)	1024 x 768	pixel	Std. 4:3
Pixel Arrangement	R.G.B Vertical Stripe	-	-
Dot Pitch (HxV)	0.0685 x 0.2055	mm	Dot
Viewing Angle (H/V)	176/176	degree	6 o'clock
Signal Interface	Digital RGB 24 bits		16.7M colors
Display Mode	Normally Black	-	-
Surface Treatment	3H Hard Coating, 25% Haze AG	-	-



2.3.2 Mechanical Dimensions

Item		Min.	Typ.	Max.	Unit	Note
Dimension	Horizontal	-	238.60	-	mm	±0.5 mm
	Vertical	-	173.20	-		±0.5 mm
	Depth	-	8.3 (temp.)	-		+0.5 mm
Weight			290 (temp.)		g	±10 g

3.0 Absolute Maximum Ratings

3.1 Absolute Ratings of Environment Requirement

Item	Symbol	Min.	Max.	Unit	Note
Storage Temperature	Tstg	-25	80	°C	
Operation Temperature (Ambient Temperature)	Top	-20	70	°C	

Note (1) Temperature and relative humidity range are shown in the figure below.

95% RH Max. ($40^{\circ}\text{C} > T_a$)

Maximum wet – bulb temperature at 39°C or less. ($T_a > 40^{\circ}\text{C}$) No condensation.

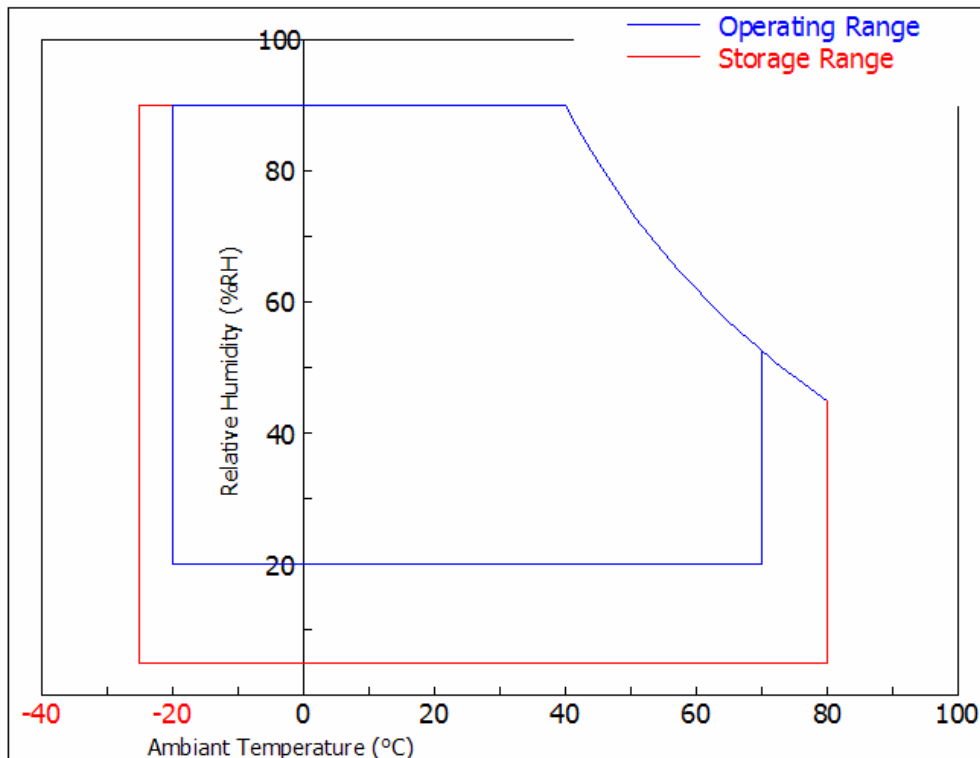



3.2 Electrical Absolute Ratings

3.2.1 TFT-LCD Module

(Ta=25±2°C), Vgg=GND=0V)

Item	SYMBOL	Min.	Max.	UNIT	NOTE
Power Supply Voltage	V _{DD}	-0.3	4.0	V	(1),(2)
Input Voltage	V _{i1}	-0.3	V _{DD} + 0.3	V	(1),(2)

3.2.2 Backlight Module(LED)

Item	SYMBOL	MIN	MAX	UNIT	NOTE
Input DC Voltage	V _{BL}	-	6.0	V	(1),(2)

Note (1) Within operating temperature

Note (2) Permanent damage to the device may occur if maximum values are exceeded. Functional operation should be restricted to the conditions described under normal operating conditions.



4.0 Optical Characteristics

The following items are measured under stable conditions in a dark room or equivalent state.

* Measuring Equipment: BM-5A, PR-650

($V_{DD}=3.3V$, $f_V=60Hz$, $f_H=48.3KHz$, $T_a=25\pm 2^\circ C$)

Item	Symbol	Condition	Min.	Typ.	Max.	Unit	Note
Contrast Ratio	CR	At optimized Viewing Angle	1000	1200	-	-	(1)(2) (4)
Response Time at 25°C	Rising	$\theta=0^\circ$	-	15	19	ms	(3)
	Falling		-	10	14		
Luminance	Y_L	$V_{Dim}=V_{max}$, 25°C	240	300	-	cd/m ²	(1)(2) (6)
Color Chromaticity (CIE 1931)	White	W_X	$\theta=0^\circ$	-	TBD	-	(2)(6)
		W_Y	$\theta=0^\circ$	-	TBD	-	
Viewing Angle	Hor.	θ_L	CR \geq 10 at center point	70	88	-	Degree (2)(5)
		θ_R		70	88	-	
	Ver.	θ_H		70	88	-	
		θ_L		70	88	-	

Note (1) : Ambient temperature =25°C, and , using the Mode 2 of LED control scheme and $V_{DIM} =0V$ to get the maximum brightness. To be measured in the dark room.

Note (2) : To be measured on the center area of panel with a viewing cone of 1° by Topcon Luminance Meter BM-5, after 10 minutes operation.

Note (3) : Definition of response time:

The output signals of photo detector are measured when the input signals are changed from “black” to “white”(falling time) and from “white” to “black”(rising time), respectively.

The response time is defined as the time interval between the 10% and 90% of amplitudes. Refer to figure as below.

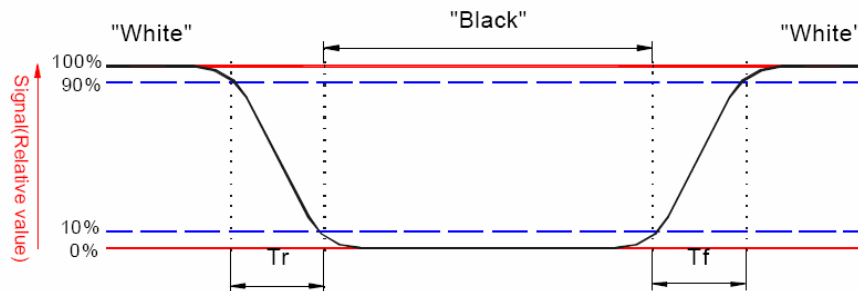

Note (4) : Definition of contrast ratio:

Contrast ratio is calculated with the following formula.



$$\text{Contrast ratio (CR)} = \frac{\text{Photo detector output when LCD is at "White" state}}{\text{Photo detector output when LCD is at "Black" state}}$$

Note (5) : Definition of viewing angle, Refer to figure as below.

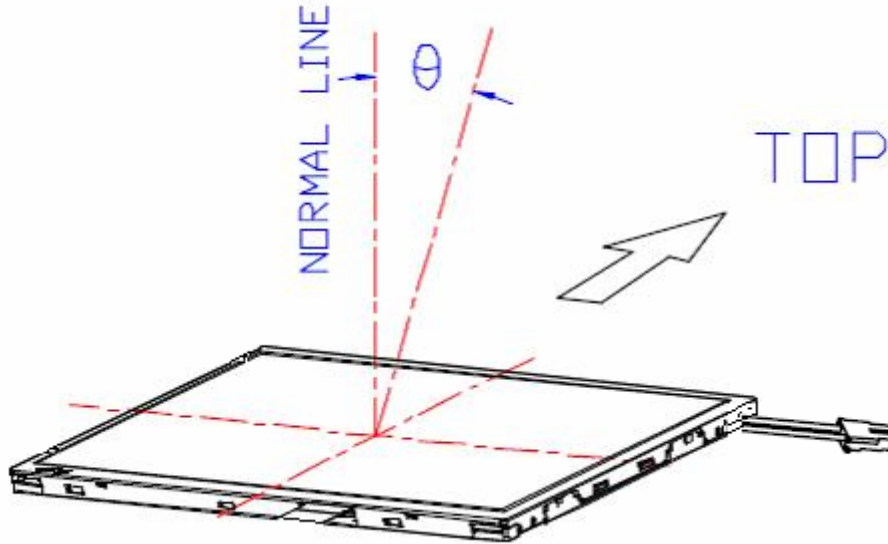

Note (6) : Measured at the center area of the panel when all the input terminals of LCD panel are electrically opened.



5.0 Electrical Characteristics

5.1 AC Timing Characteristics

Signal	Item	Symbol	Min.	Typ.	Max.	Unit	Note
LVDS Clock	Frequency	Fc	57.5	64.9	74.4	MHz	-
	Period	Tc	13.4	15.4	17.3	ns	
Vertical Active Display Term	Frame Rate	Fr	56	60	75	Hz	Tv=Tvd+Tvb
	Total	Tv	774	806	848	Th	-
	Display	Tvd	768	768	768	Th	-
	Blank	Tvb	Tv-Tvd	38	Tv-Tvd	Th	-
Horizontal Active Display Term	Total	Th	1240	1344	1464	Tc	Th=Thd+Thb
	Display	Thd	1024	1024	1024	Tc	-
	Blank	Thb	Th-Thd	320	Th-Thd	Tc	-

Note : (1) Hsync and Vsync input signals should be set to low logic level or ground because this LCD module is operated by "DE only" mode. Otherwise, this module would operate abnormally.

5.2 DC Characteristics

5.2.1 TFT-LCD Module

Item	Symbol	Min.	Typ.	Max.	Unit	Note
Power Supply	V _{DD}	3.0	3.3	3.6	V	(1)
Permissive Input Ripple Voltage	V _{RF}	-	-	100	mV _{P-P}	
Power Supply Current	(White)	-	1.1	-	A	V _{DD} =3.3V
	(Black)	-	0.8	-	A	V _{DD} =3.3V
	(Vertical Stripe)	-	1.0	-	A	V _{DD} =3.3V
LVDS Differential Input voltage	V _{id}	-100		100	mV	
LVDS Common Input DC volatge	V _{ic}		1.2		V	
Logic Input Voltage	V _{IL}	0	-	0.7	V	(2)
	V _{IH}	2.7	-	V _{DD}	V	(2)

Note (1) VDD Power-On Condition :

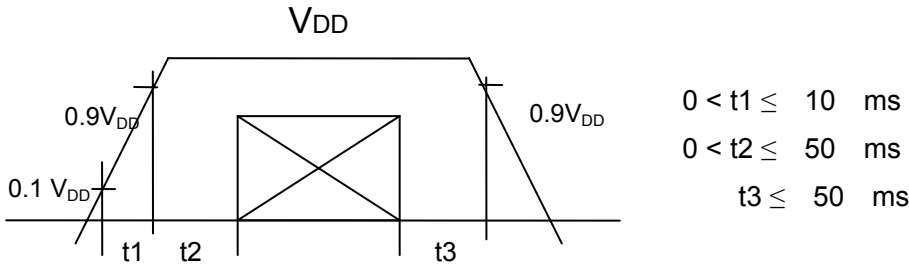

Note (2) for signal "DPSR"

5.2.2 Backlight Unit & LED Driver

Item	Symbol	Min.	Typ.	Max.	Unit	Note
Power Supply	V_{BL}	4.5	5	5.5	V	
	I_{BL}		1.0		Amp	Note 1
Operation Life Time	Hr		30,000		Hours	Note 2

Note 1 : $V_{BL} = +5V$, using the Mode 2 of LED control scheme and $V_{DIM} = 0V$ to get the maximum brightness.

Note 2 : 50% decay of initial brightness, operated at 25°C ambient environment continuously.

Note 3 : V_{BL} Power-On Condition for LED driver :

Please make sure the control signals must arrive after the power supply of LED driver, V_{BL} .

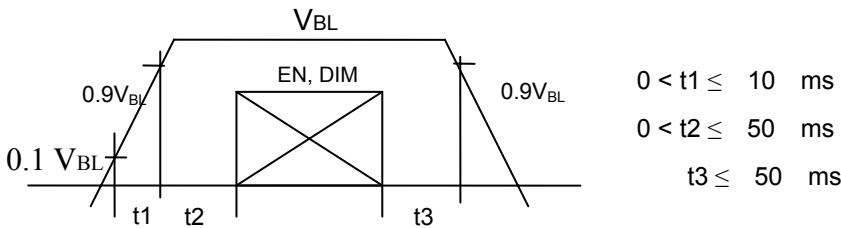

5.3 Input Terminal Pin Assignment

5.3.1 Signal Input Interface

Input Connector : JAE, FI-XB30SRL-HF11

CN101

Matching Connector : JAE, FI-X30C2L or equivalent

Pin No	Symbol	Description	Remark
1	NC	No Connection	-
2	GND	Ground	-
3	RxIN3+	LVDS receiver signal channel 3	R6~R7, G6~G7 B6~B7
4	RxIN3-		
5	GND	Ground	-
6	CLKIN+	LVDS receiver signal clock	
7	CLKIN-		
8	GND	Ground	-
9	RxIN2+	LVDS receiver signal channel 2	B2~B5, DE, Hsync, Vsync
10	RxIN2-		



11	GND	Ground	-
12	RxIN1+	LVDS receiver signal channel 1	G1~G5, B0, B1
13	RxIN1-		
14	GND	Ground	-
15	RxIN0+	LVDS receiver signal channel 0	R0~R5, G0
16	RxIN0-		
17	GND	Ground	-
18	STPV	Vertical Start Pulse Output	-
19	GND	Ground	-
20	NC	No Connection	-
21	NC	No Connection	-
22	NC	No Connection	-
23	NC	No Connection	-
24	DPSR	Screen Rotation	-
25	GND	Ground	-
26	GND	Ground	-
27	GND	Ground	-
28	V _{DD}	Power Supply (+3.3V)	-
29	V _{DD}	Power Supply (+3.3V)	-
30	V _{DD}	Power Supply (+3.3V)	-

5.3.2 LED Driver Unit (LD104X1D3) CN201

Connector: 1.25mm pitch Hirose P/N: DF13-7P-1.25DSA20 (Matching CN:DF13-7S-1.25C)

Pin No.	Symbol	Description	Remark
1	GND	Ground Pin for LED Driver	
2	GND	Ground Pin for LED Driver	
3	DIM	Dimming Control Input	Note 2
4	EN	LED Enable Control Input	Note 1
5	V _{BL}	Power Supply for LED Driver (+5V)	
6	V _{BL}	Power Supply for LED Driver (+5V)	
7	N.C.	No Connection	

Note 1 : Disable V_{EN}<0.6 V, Enable V_{EN}>1.8 V

Note 2 : Max Brightness V_{DIM} : 0V, Min Brightness V_{DIM} : 5V (≈ 0 Nit)



5.3.3 Scanning Direction

Viewing Direction : Front View Arrow Head Direction : Scanning Sequence

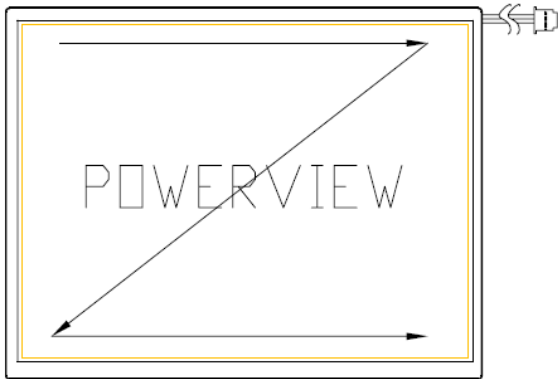

Figure A. Normal Scan, DPSR: Low or Open

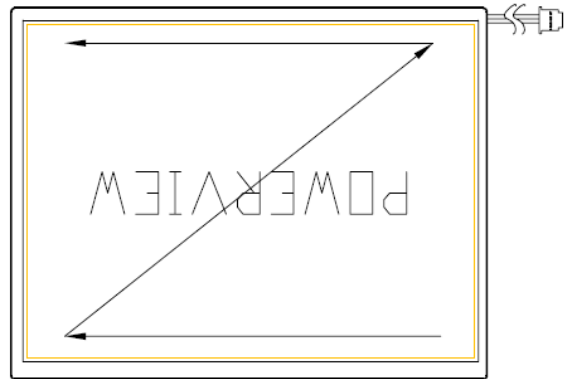

Figure B. Reverse Scan, DPSR: High

5.3.4 Color Data Reference

The below table is about nput signal, Basic display colors and gray scale of each color.

0 : Low Level Voltage 1 : High Level Voltage

Each basic color can be displayed in 64 gray scales from 6 bit data signals. With the combination of total 18 bit data signals, the 262,144 color display can be achieved on the screen.

- Please refer to the next page



	Colors & Gray Scale	Data Signal																											
		Gray Scale	R0	R1	R2	R3	R4	R5	R6	R7	G0	G1	G2	G3	G4	G5	G6	G7	B0	B1	B2	B3	B4	B5	B6	B7			
Basic Color	Black	-	0	0	0	0	0	0	0	0	0	0	0	0	0	0	0	0	0	0	0	0	0	0	0	0	0	0	
	Blue	-	0	0	0	0	0	0	0	0	0	0	0	0	0	0	0	0	1	1	1	1	1	1	1	1	1	1	
	Green	-	0	0	0	0	0	0	0	0	1	1	1	1	1	1	1	1	0	0	0	0	0	0	0	0	0	0	
	Cyan	-	0	0	0	0	0	0	0	0	1	1	1	1	1	1	1	1	1	1	1	1	1	1	1	1	1	1	
	Red	-	1	1	1	1	1	1	1	1	0	0	0	0	0	0	0	0	0	0	0	0	0	0	0	0	0	0	
	Magenta	-	1	1	1	1	1	1	1	1	0	0	0	0	0	0	0	0	1	1	1	1	1	1	1	1	1	1	
	Yellow	-	1	1	1	1	1	1	1	1	1	1	1	1	1	1	1	1	0	0	0	0	0	0	0	0	0	0	
	White	-	1	1	1	1	1	1	1	1	1	1	1	1	1	1	1	1	1	1	1	1	1	1	1	1	1	1	
Gray Scale of Red	Black	GS0	0	0	0	0	0	0	0	0	0	0	0	0	0	0	0	0	0	0	0	0	0	0	0	0	0	0	
	↑	GS1	1	0	0	0	0	0	0	0	0	0	0	0	0	0	0	0	0	0	0	0	0	0	0	0	0	0	
	Darker	GS2	0	1	0	0	0	0	0	0	0	0	0	0	0	0	0	0	0	0	0	0	0	0	0	0	0	0	
	↑	↓					↓							↓											↓				
	↓	↓					↓							↓											↓				
	Brighter	GS253	1	0	1	1	1	1	1	1	0	0	0	0	0	0	0	0	0	0	0	0	0	0	0	0	0	0	
	↓	GS254	0	1	1	1	1	1	1	1	0	0	0	0	0	0	0	0	0	0	0	0	0	0	0	0	0	0	
	Red	GS255	1	1	1	1	1	1	1	1	0	0	0	0	0	0	0	0	0	0	0	0	0	0	0	0	0	0	
Gray Scale of Green	Black	GS0	0	0	0	0	0	0	0	0	0	0	0	0	0	0	0	0	0	0	0	0	0	0	0	0	0	0	
	↑	GS1	0	0	0	0	0	0	0	0	1	0	0	0	0	0	0	0	0	0	0	0	0	0	0	0	0	0	
	Darker	GS2	0	0	0	0	0	0	0	0	0	1	0	0	0	0	0	0	0	0	0	0	0	0	0	0	0	0	
	↑	↓					↓							↓											↓				
	↓	↓					↓							↓											↓				
	Brighter	GS253	0	0	0	0	0	0	0	0	1	0	1	1	1	1	1	1	0	0	0	0	0	0	0	0	0	0	
	↓	GS254	0	0	0	0	0	0	0	0	0	1	1	1	1	1	1	1	0	0	0	0	0	0	0	0	0	0	
	Green	GS255	0	0	0	0	0	0	0	0	1	1	1	1	1	1	1	1	0	0	0	0	0	0	0	0	0	0	
Gray Scale of Blue	Black	GS0	0	0	0	0	0	0	0	0	0	0	0	0	0	0	0	0	0	0	0	0	0	0	0	0	0	0	
	↑	GS1	0	0	0	0	0	0	0	0	0	0	0	0	0	0	0	0	1	0	0	0	0	0	0	0	0	0	
	Darker	GS2	0	0	0	0	0	0	0	0	0	0	0	0	0	0	0	0	0	1	0	0	0	0	0	0	0	0	
	↑	↓					↓							↓											↓				
	↓	↓					↓							↓											↓				
	Brighter	GS253	0	0	0	0	0	0	0	0	0	0	0	0	0	0	0	0	1	0	1	1	1	1	1	1	1	1	
	↓	GS254	0	0	0	0	0	0	0	0	0	0	0	0	0	0	0	0	0	1	1	1	1	1	1	1	1	1	
	Blue	GS255	0	0	0	0	0	0	0	0	0	0	0	0	0	0	0	0	1	1	1	1	1	1	1	1	1	1	

This specification data sheet is an intellectual property of PowerView Display Corporation. Any copy, reproduction or modification without written permission of PowerView Display Corporation is not allowed.

5.4 Input Timing Chart

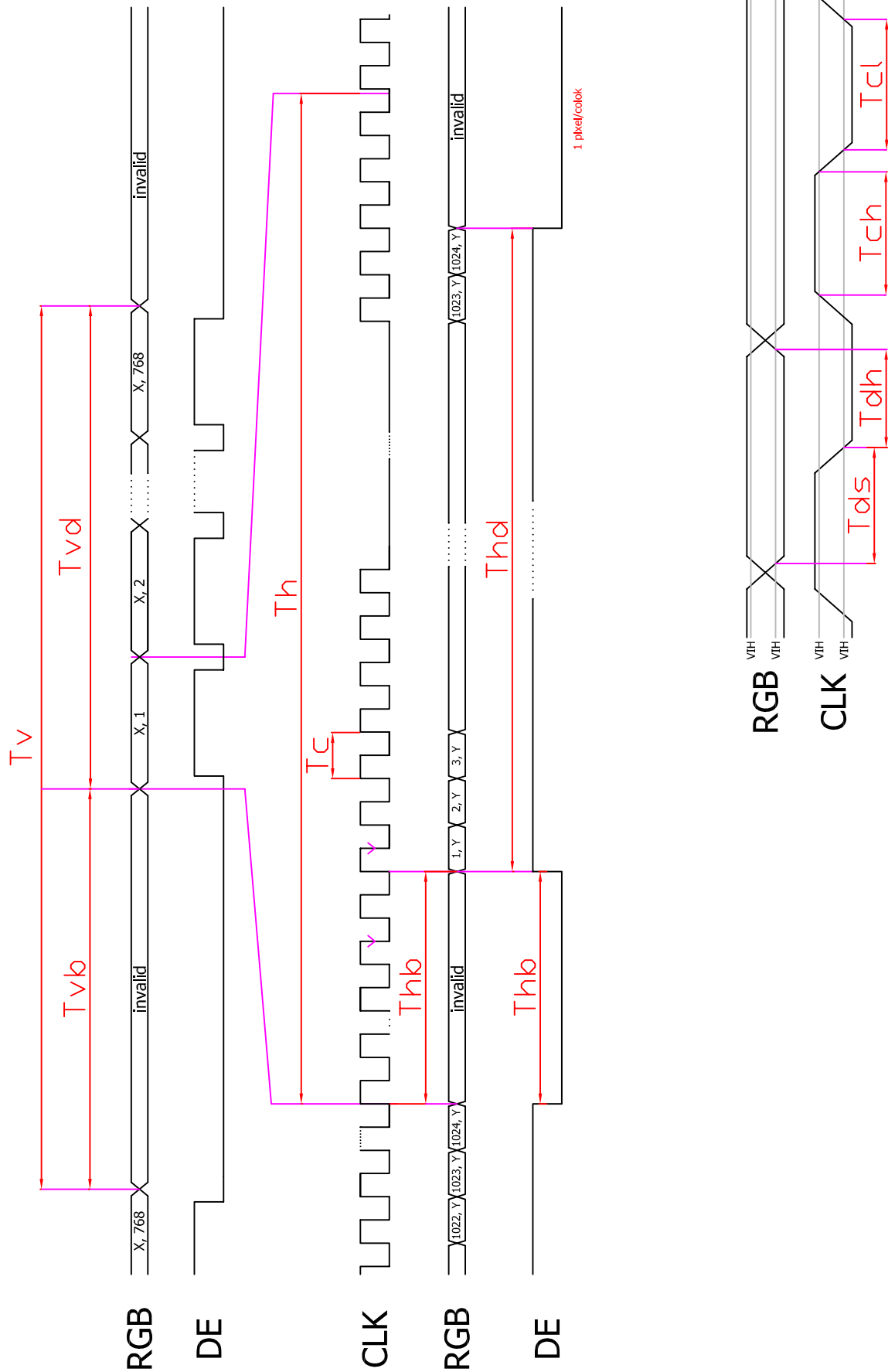



6.0 Pixel Format Image

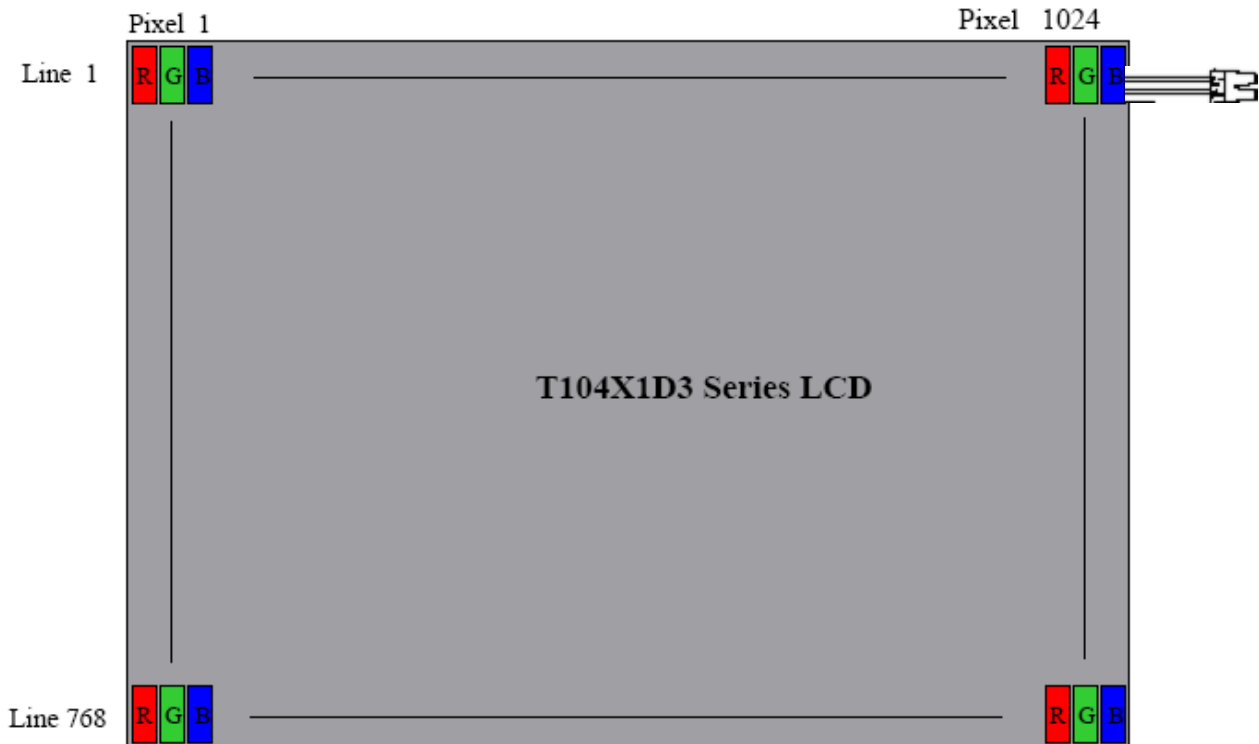

7.0 Display Outline Dimensions

7.1 Monitor Outline Dimensions

- Please refer to the next page

A B C D E F 1 2 3 4 5 6 7 8 9 10 11 12

REV	EC NUMBER	DESCRIPTION	DATE
▽	XXXXXXXX	XXXXXXXX	

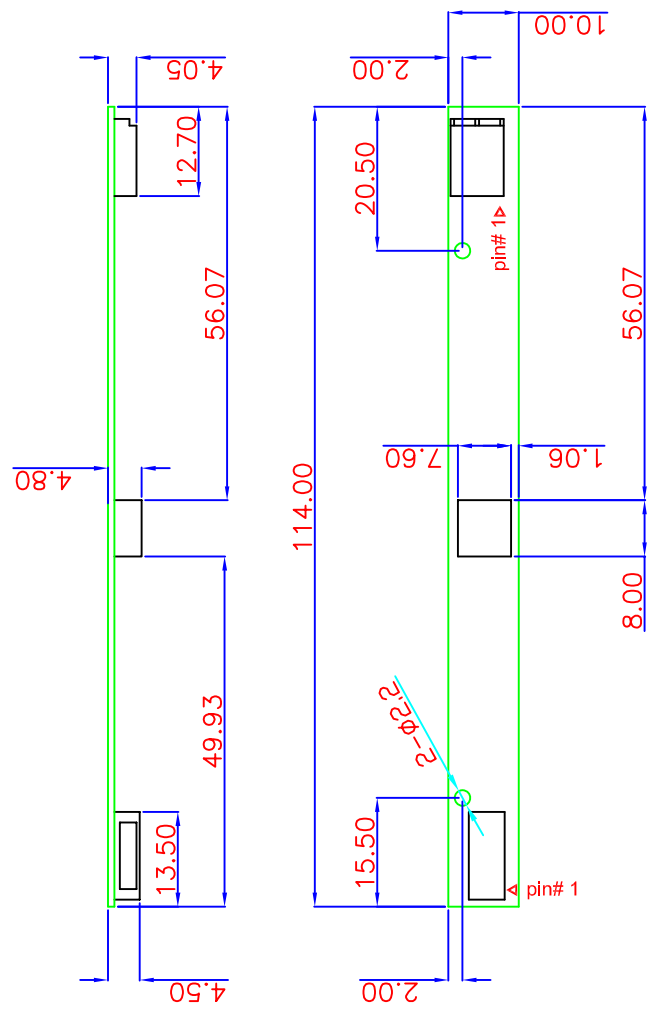
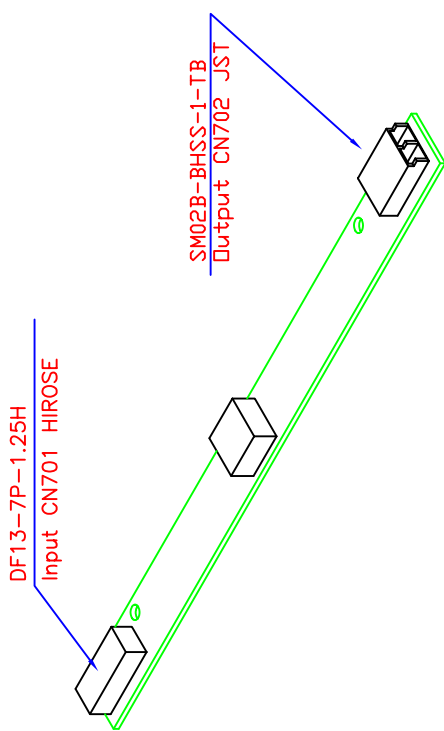

POWERVIEW DISPLAY CORPORATION				All Rights Reserved	
MATERIAL	See notes	FINISH	Finish	APPROVED	CHECKED
DF13-7P-1.25H		SM02B-BHSS-1-TB			
U0104X103		LED Driver (+5V)			
LED Driver (+5V)		LED Driver (+5V)			
2008/07/28		2008/07/28			
Neal Chen		Neal Chen			
A4		A4			
1-1		1-1			

LEVEL	MIN	MAX	MIN	MAX
1 - 4	0.1	0.2	0.2	0.2
5 - 14	0.1	0.2	0.2	0.2
15 - 25	0.1	0.2	0.2	0.2
26 - 60	0.1	0.2	0.2	0.2
61 - 65	0.1	0.2	0.2	0.2
66 - 68	0.1	0.2	0.2	0.2
69 - 70	0.1	0.2	0.2	0.2

1 2 3 4 5 6 7 8 9 10 11 12

A B C D E F



8.0 Labeling, Packaging & Others

* Labeling

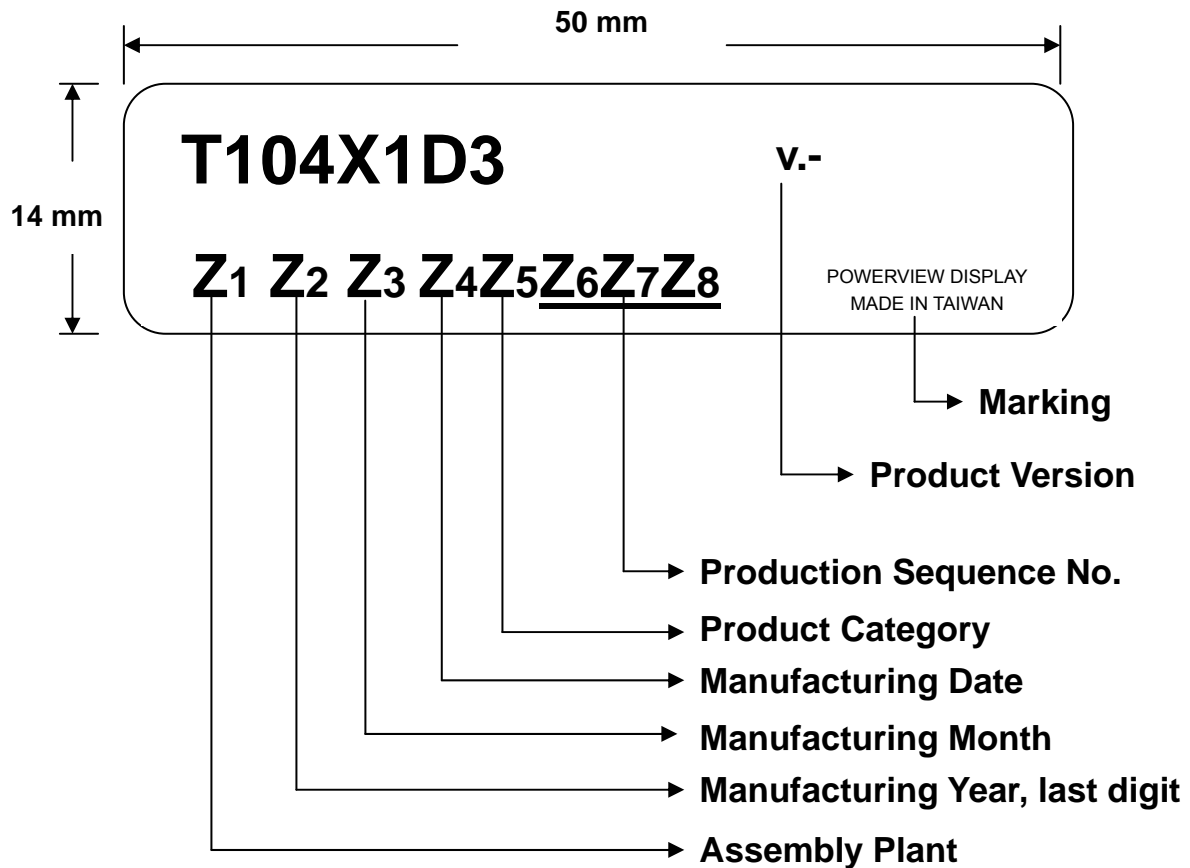

* Packaging

- TBD



To Be Updated



9.0 General Notice

9.1 Reliability Test Items (Note 2)

No.	Test Items	Conditions	Remark
1	High Temperature Storage	Ta= + 80°C 240 Hrs	
2	Low Temperature Storage	Ta= - 25°C 240 Hrs	
3	High Temperature Operation	Ta= + 70°C 240 Hrs	
4	Low Temperature Operation	Ta= - 20°C 240 Hrs	
5	High Temperature and High Humidity	Tp= 60°C, 90%RH 240 Hrs	operation
6	Heat Shock	-25~80°C/200 cycles 1Hr/cycle	Non-operation
7	Electrostatic discharge	±200V, 200pF(0Ω), once for each terminal	Non-operation
8	Vibration	Frequency range : 8~33.3 Hz Stoke : 1.3mm Sweep : 2.9G, 33.3~400Hz Cycle : 15 minutes 2 hours for each direction of X,Z 4 hours for Y direction	JIS C7021, A-10 Condition A
9	Mechanical Shock	100G, 6ms, ±X±Y±Z 3 times for each direction	JIS C7021, A-7 Condition C
10	Vibration (with carton)	Random vibration : 0.015G ² /Hz from 5~200Hz -6dB/octave from 200~500Hz	IEC 68-34
11	Drop (with carton)	Height : 60 cm 1 corner, 3 edges, 6 surfaces	JIS Z0202

Note1: Ta: Ambient temperature.

Note 2: In the standard conditions, there is not display function NG issue occurred. All the cosmetic specification is judged before the reliability stress.



9.2 Storage, Operation & Others

- (a) Do not leave the panel in high temperature, and high humidity for a long time.
It is highly recommended to store the module with temperature from 0 to 35°C and relative humidity of less than 70%.
- (b) Do not store the TFT-LCD module in direct sunlight.
- (c) The module shall be stored in a dark place. It is prohibited to apply sunlight or fluorescent light during the store.
- (d) Do not connect, disconnect the module in the "Power On" condition.
- (e) Power supply should always be turned on/off by the item 3.2 "Electrical Absolute Ratings"
- (f) The liquid-crystal is deteriorated by ultraviolet rays. Do not leave it in direct sunlight and strong ultraviolet rays for many hours.
- (g) Avoid condensation of water. It may result in improper operation or disconnection of electrode.
- (h) Do not exceed the absolute maximum rating value. (the supply voltage variation, input voltage variation, variation in part contents and environmental temperature, and so on) Otherwise the panel may be damaged.
- (i) If the panel displays the same pattern continuously for a long period of time, it can be the situation when the image "Sticks" to the screen.
- (j) This panel has its circuitry FPC on the bottom side and should be handled carefully in order not to be stressed.